

Generalized Parton Distributions with CLAS and CLAS12

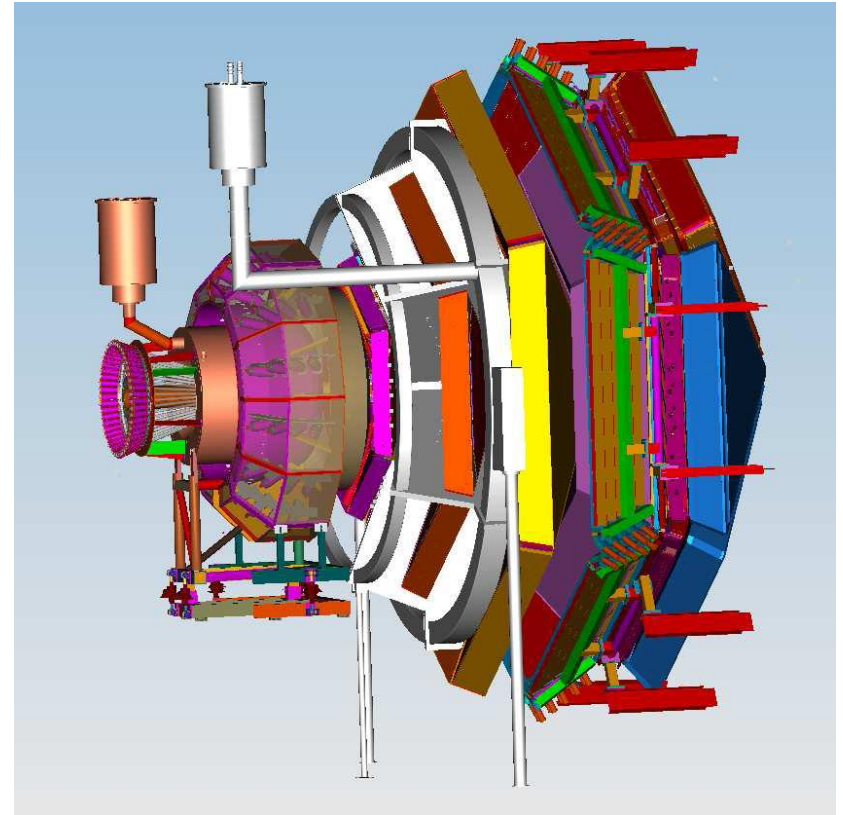
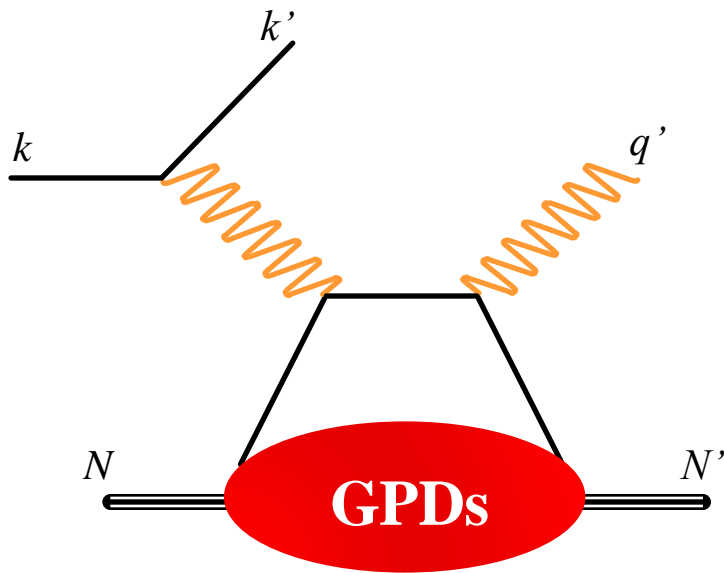

Silvia Niccolai  for the CLAS Collaboration

From Quarks and Gluons to Hadrons and Nuclei
Erice (Italia) – September 22nd 2011

Generalized Parton Distributions with CLAS and CLAS12

- Interest of GPDs
- GPDs and Deeply Virtual Compton Scattering
 - The CLAS detector
 - DVCS results with CLAS
- GPDs and Deeply Virtual Meson Production
 - DVMP results with CLAS
 - The JLab 12 GeV upgrade and CLAS12
- Future experiments on GPDs with CLAS12

Silvia Niccolai  for the CLAS Collaboration

From Quarks and Gluons to Hadrons and Nuclei
Erice (Italia) – September 22nd 2011

Generalized Parton Distributions

GPDs: $H, E, \tilde{H}, \tilde{E}$
Fully correlated quark distributions in both coordinate and momentum space

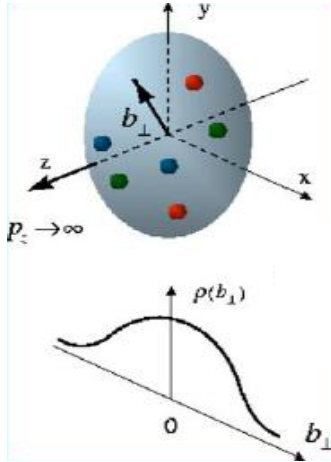

Form factors:
transverse quark distribution in coordinate space

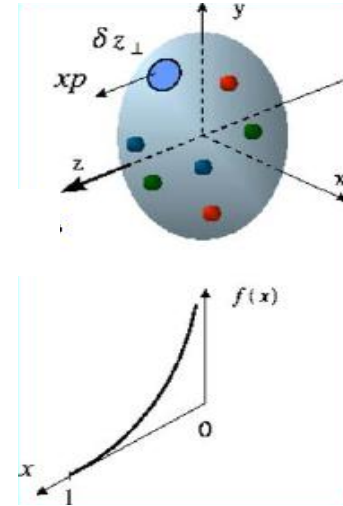

Parton distributions:
longitudinal quark distribution in momentum space

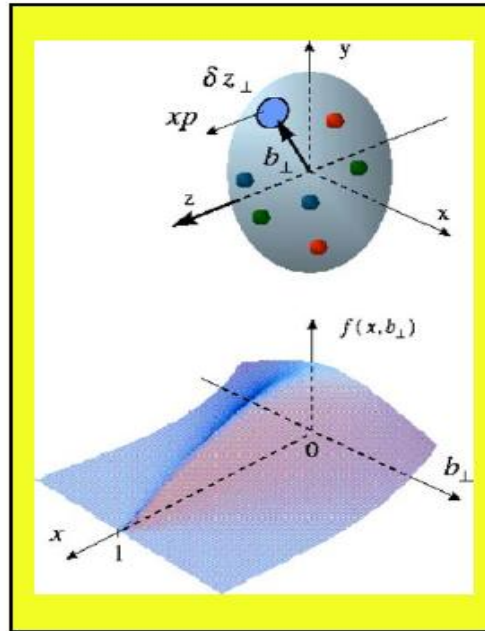

Accessible in hard exclusive processes

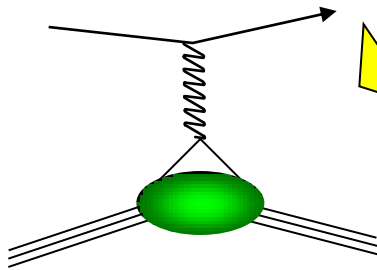

$$\int H(x, \xi, t) dx = F_1(t) \quad (\forall \xi)$$

$$\int E(x, \xi, t) dx = F_2(t) \quad (\forall \xi)$$

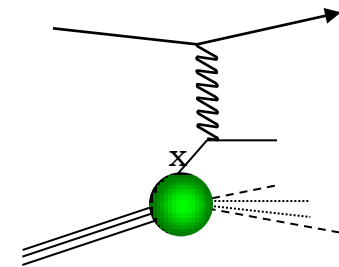

$$H(x, 0, 0) = q(x),$$

$$\tilde{H}(x, 0, 0) = \Delta q(x)$$

Deeply Virtual Compton Scattering and GPDs

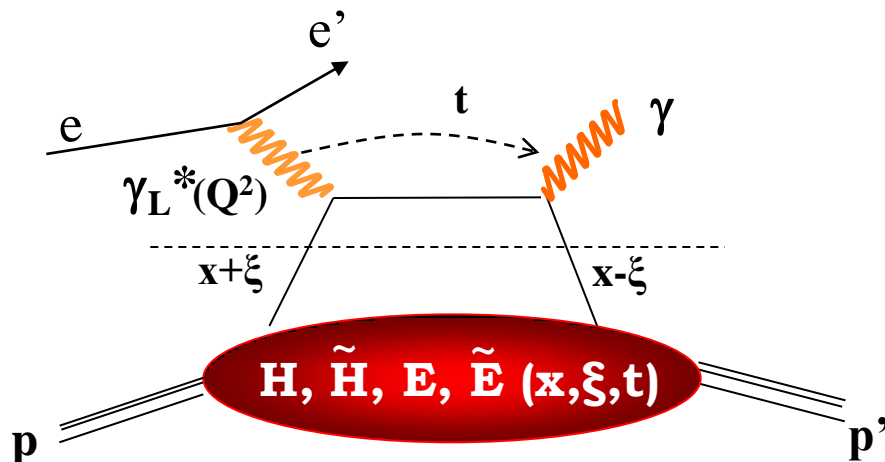

- $Q^2 = - (e-e')^2$
- $x_B = Q^2/2Mv$ $v = E_e - E_{e'}$
- $x+\xi, x-\xi$ longitudinal momentum fractions
- $t = (p-p')^2$
- $\xi \cong x_B/(2-x_B)$

4 GPDs for each quark flavor

conserve nucleon helicity

Vector: $H(x, \xi, t)$ Axial-Vector: $\tilde{H}(x, \xi, t)$

Tensor: $E(x, \xi, t)$ Pseudoscalar: $\tilde{E}(x, \xi, t)$

flip nucleon helicity

« Handbag » factorization valid
in the Bjorken regime:
high Q^2 , v (fixed x_B), $t \ll Q^2$

Quark angular momentum (Ji's sum rule)

$$J^q = \frac{1}{2} - J^G = \frac{1}{2} \int_{-1}^1 x dx [H^q(x, \xi, 0) + E^q(x, \xi, 0)]$$

X. Ji, Phy.Rev.Lett.78,610(1997)

«3D» quark/gluon
image of
the nucleon

Accessing GPDs through DVCS

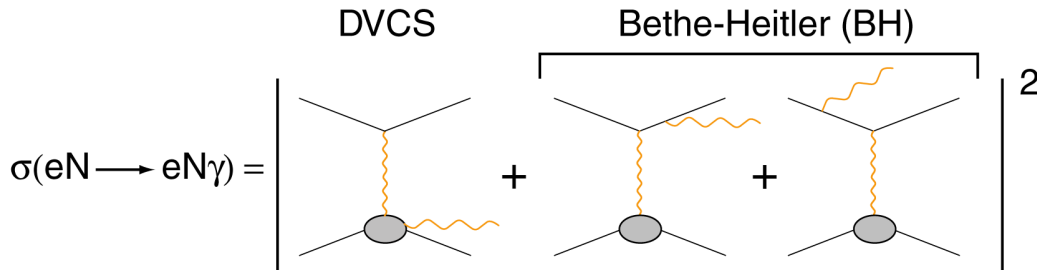

$$\sigma \sim |T^{\text{DVCS}} + T^{\text{BH}}|^2$$

$$\Delta\sigma = \sigma^+ - \sigma^- \propto I(\text{DVCS} \cdot \text{BH})$$

$$A = \frac{\Delta\sigma}{2\sigma} \propto \frac{I(\text{DVCS} \cdot \text{BH})}{|\text{BH}|^2 + |\text{DVCS}|^2 + I}$$

$$T^{\text{DVCS}} \sim \int_{-1}^{+1} \frac{GPDs(x, \xi, t)}{x \pm \xi + i\epsilon} dx + \dots \sim P \int_{-1}^{+1} \frac{GPDs(x, \xi, t)}{x \pm \xi} dx \pm i\pi GPDs(\pm\xi, \xi, t) + \dots$$

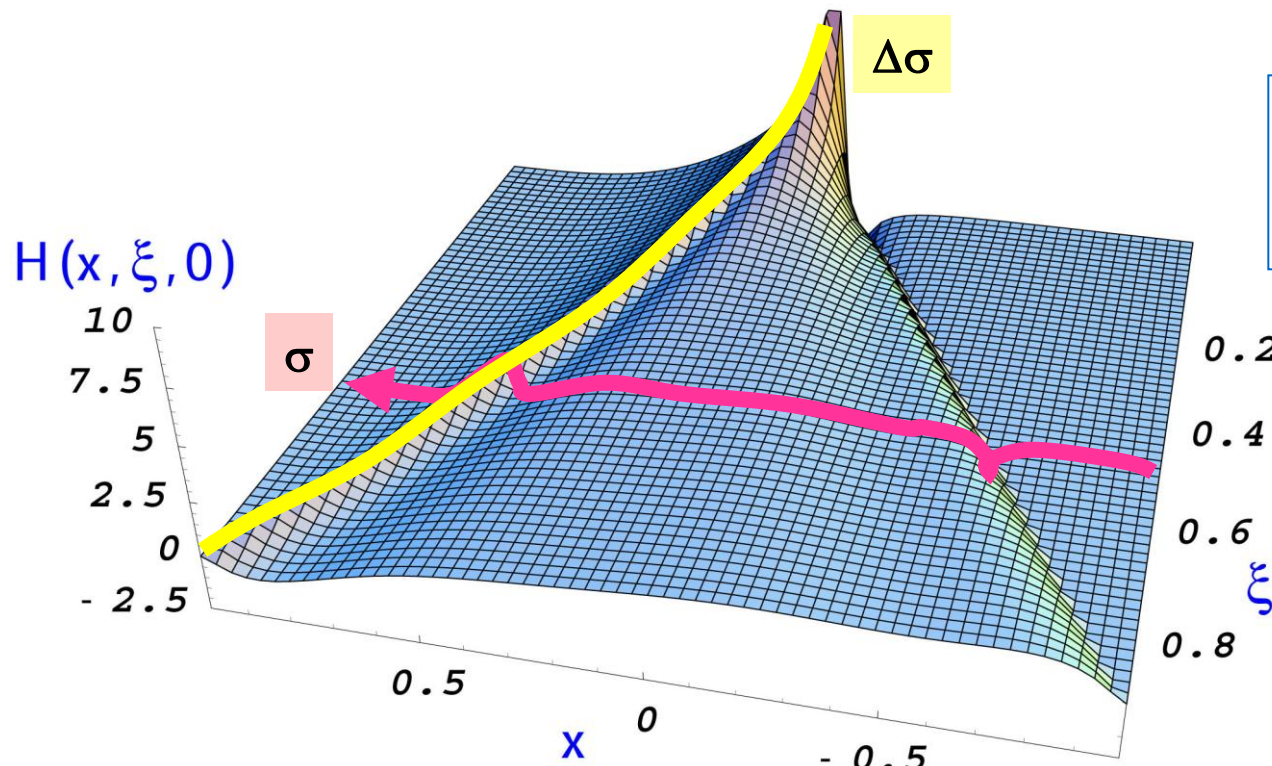

Only ξ and t are accessible experimentally

Sensitivity to GPDs of DVCS spin observables

$$Re\mathcal{H}_q = e_q^2 P \int_0^{+1} \left(H^q(x, \xi, t) - H^q(-x, \xi, t) \right) \left[\frac{1}{\xi - x} + \frac{1}{\xi + x} \right] dx$$

$$Im\mathcal{H}_q = \pi e_q^2 \left[H^q(\xi, \xi, t) - H^q(-\xi, \xi, t) \right]$$

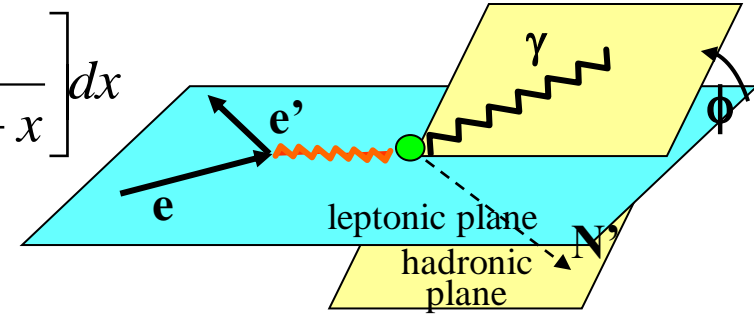

$$\xi = x_B / (2 - x_B) \quad \mathbf{k} = -\mathbf{t} / 4M^2$$

Proton Neutron

Polarized beam, unpolarized target:

$$\Delta\sigma_{LU} \sim \sin\phi \operatorname{Im}\{F_1\mathcal{H} + \xi(F_1+F_2)\tilde{\mathcal{H}} - kF_2\mathcal{E}\} d\phi$$

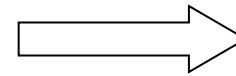

$$\operatorname{Im}\{\mathcal{H}_p, \tilde{\mathcal{H}}_p, \mathcal{E}_p\}$$

$$\operatorname{Im}\{\mathcal{H}_n, \tilde{\mathcal{H}}_n, \mathcal{E}_n\}$$

Unpolarized beam, longitudinal target:

$$\Delta\sigma_{UL} \sim \sin\phi \operatorname{Im}\{F_1\tilde{\mathcal{H}} + \xi(F_1+F_2)(\mathcal{H} + x_B/2\mathcal{E}) - \xi kF_2\tilde{\mathcal{E}} + \dots\} d\phi$$

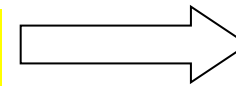

$$\operatorname{Im}\{\mathcal{H}_p, \tilde{\mathcal{H}}_p\}$$

$$\operatorname{Im}\{\mathcal{H}_n, \mathcal{E}_n, \tilde{\mathcal{E}}_n\}$$

Polarized beam, longitudinal target:

$$\Delta\sigma_{LL} \sim (A + B\cos\phi) \operatorname{Re}\{F_1\tilde{\mathcal{H}} + \xi(F_1+F_2)(\mathcal{H} + x_B/2\mathcal{E}) \dots\} d\phi$$

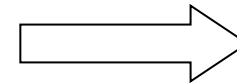

$$\operatorname{Re}\{\mathcal{H}_p, \tilde{\mathcal{H}}_p\}$$

$$\operatorname{Re}\{\mathcal{H}_n, \mathcal{E}_n, \tilde{\mathcal{E}}_n\}$$

Unpolarized beam, transverse target:

$$\Delta\sigma_{UT} \sim \sin\phi \operatorname{Im}\{k(F_2\mathcal{H} - F_1\mathcal{E}) + \dots\} d\phi$$

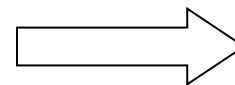

$$\operatorname{Im}\{\mathcal{H}_p, \mathcal{E}_p\}$$

$$\operatorname{Im}\{\mathcal{H}_n\}$$

The CLAS detector (Jefferson Lab, Hall B)

CEBAF
Large
Acceptance
Spectrometer

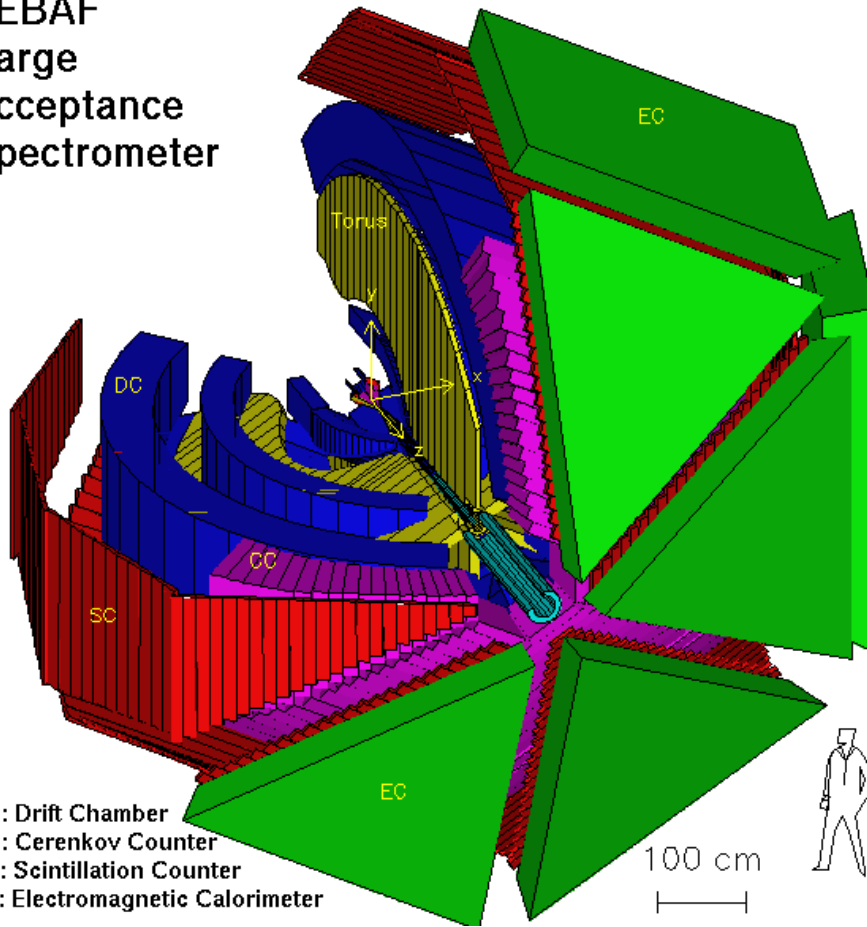

- **Toroidal magnetic field (6 supercond. coils)**
- **Drift chambers (argon/CO₂ gas, 35000 cells)**
- **Time-of-flight scintillators**
- **Electromagnetic calorimeters**
- **Cherenkov Counters (e/π separation)**

Performances:

- **large acceptance** for charged particles
 $8^\circ < \theta < 142^\circ$, $p_p > 0.3 \text{ GeV}/c$, $p_\pi > 0.1 \text{ GeV}/c$
- **good momentum and angular resolution**
 $\Delta p/p \leq 0.5\% - 1.5\%$, $\Delta\theta, \Delta\phi \leq 1 \text{ mrad}$

Optimal for measurements of exclusive reactions with multi-particle final states

The e1-DVCS experiment

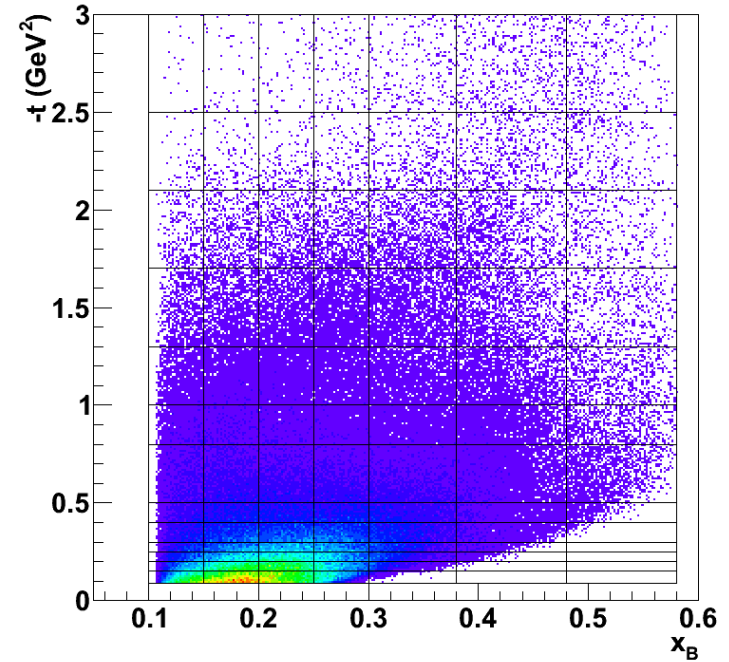
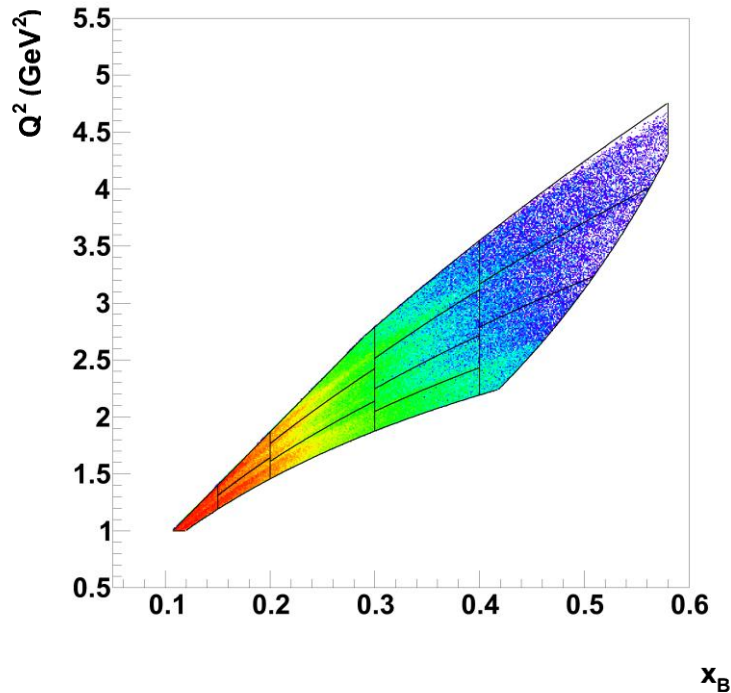

Part 1 of the e1-DVCS experiment:

- Data taken from March 11 until May 27, 2005
- Beam energy ~ 5.766 GeV
- Beam current = 20-25 nA
- Beam polarization $\sim 80\%$
- Integrated luminosity $\sim 3.33 \times 10^7$ nb $^{-1}$
- Target LH₂

CLAS + Solenoid (Moeller shield) + IC

More data taken in fall 2008, under analysis

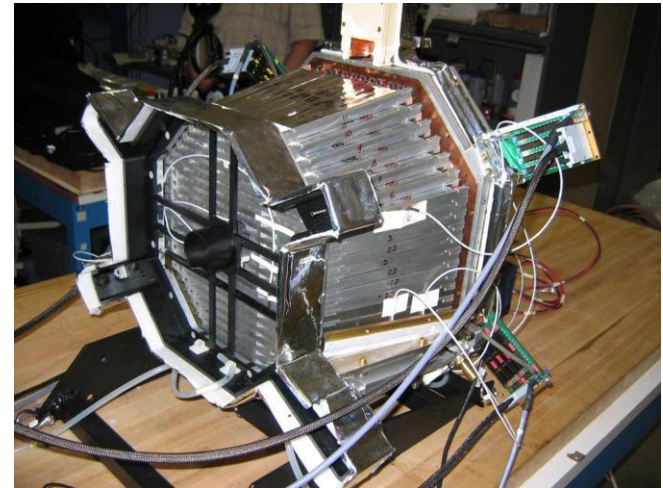

IC (inner calorimeter)
424 lead tungstate crystals + APD readout

DVCS Beam Spin Asymmetries

$ep \rightarrow epy$

$$\Delta\sigma_{LU} \sim \sin\phi \operatorname{Im}\{F_1\mathcal{H} + \xi(F_1+F_2)\tilde{\mathcal{H}} - kF_2\mathcal{E}\}d\phi$$

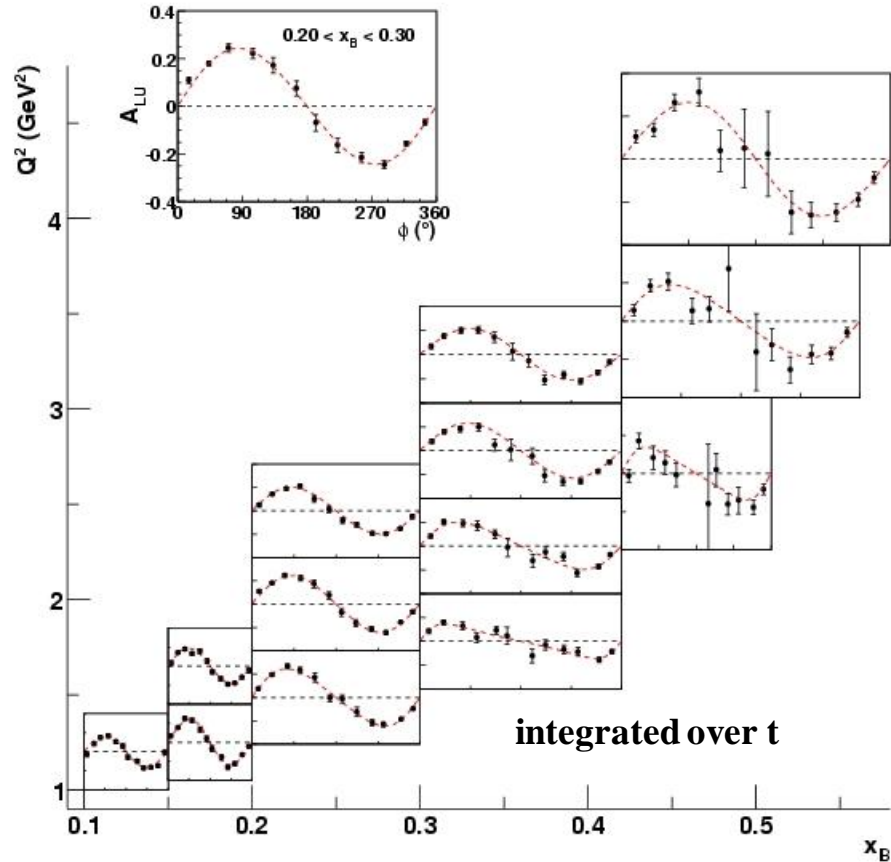

$$\text{Fit} = a \sin\phi / (1 + b \cos\phi)$$

F.X. Girod et al. (CLAS Collaboration),
Phys. Rev. Lett. 100, 162002 (2008)

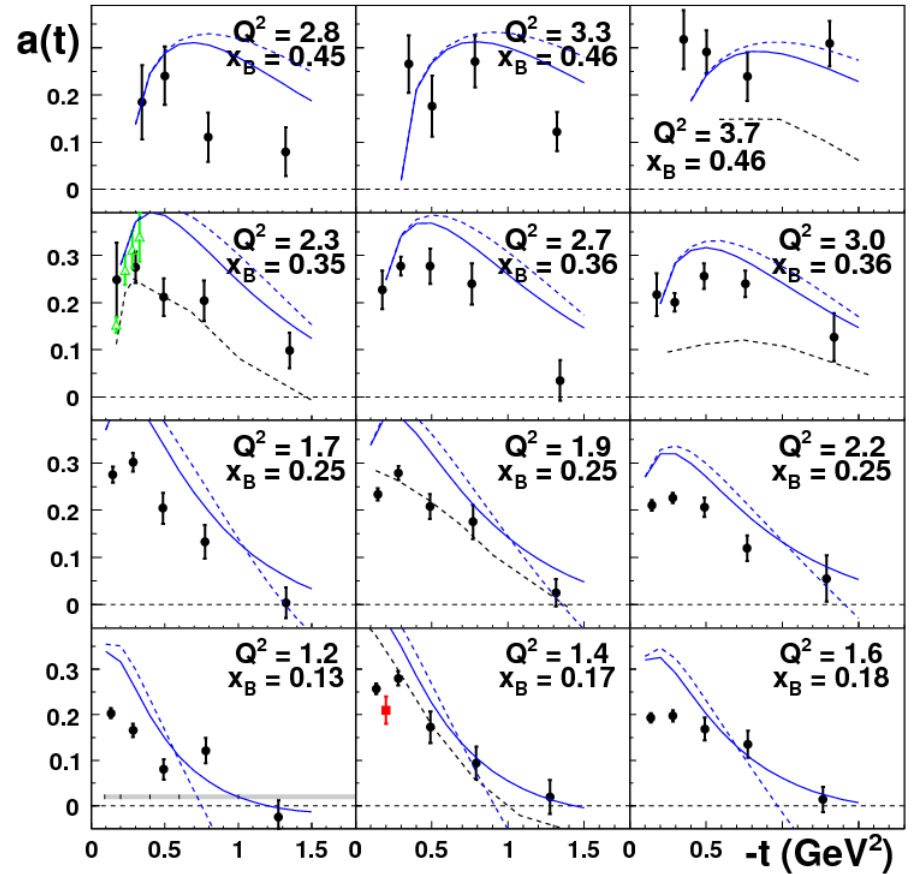

- CLAS e1-dvcs
- ▲ Hall A
- CLAS @ 4.3 GeV²
- VGG(*) twist-2 (DD)
- - - VGG(*) twist-2 and 3
- Regge model (**)

(*) Guidal, Polyakov, Radyushkin,
Vanderhaegen, PRD 72 (2005)

(**) Cano and Laget, PL B551 (2003)

DVCS Beam Spin Asymmetries

$ep \rightarrow epy$

$$\Delta\sigma_{LU} \sim \sin\phi \operatorname{Im}\{F_1\mathcal{H} + \xi(F_1+F_2)\tilde{\mathcal{H}} - kF_2\mathcal{E}\}d\phi$$

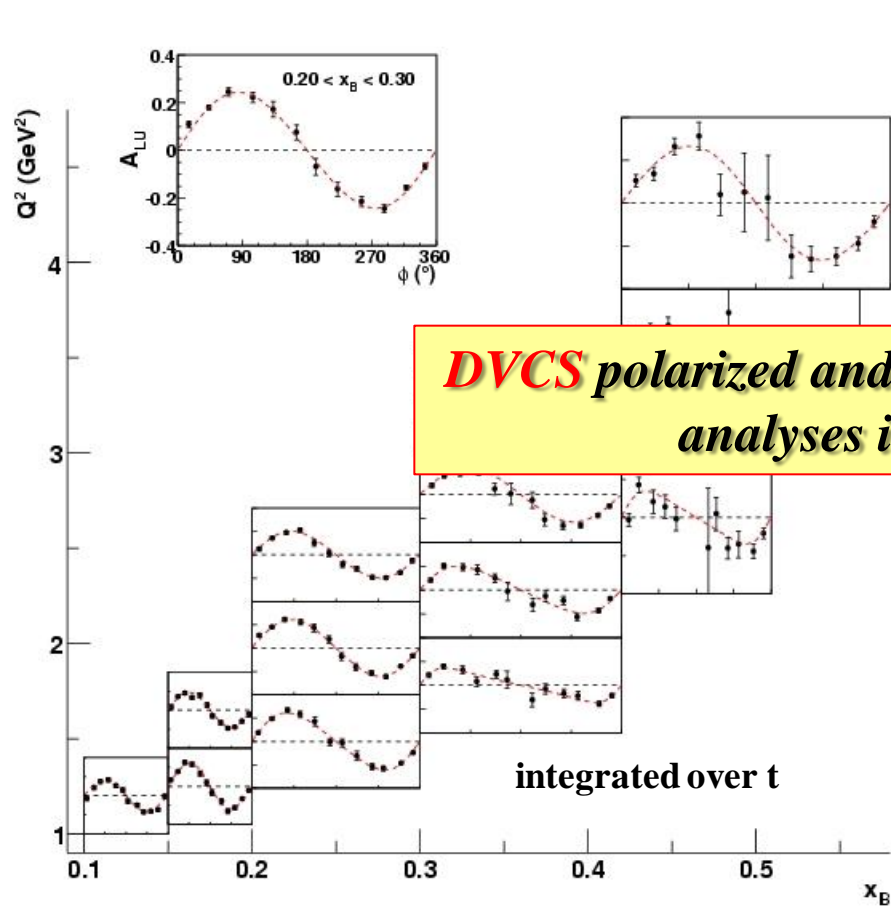

DVCS polarized and unpolarized cross sections: analyses in the final stages

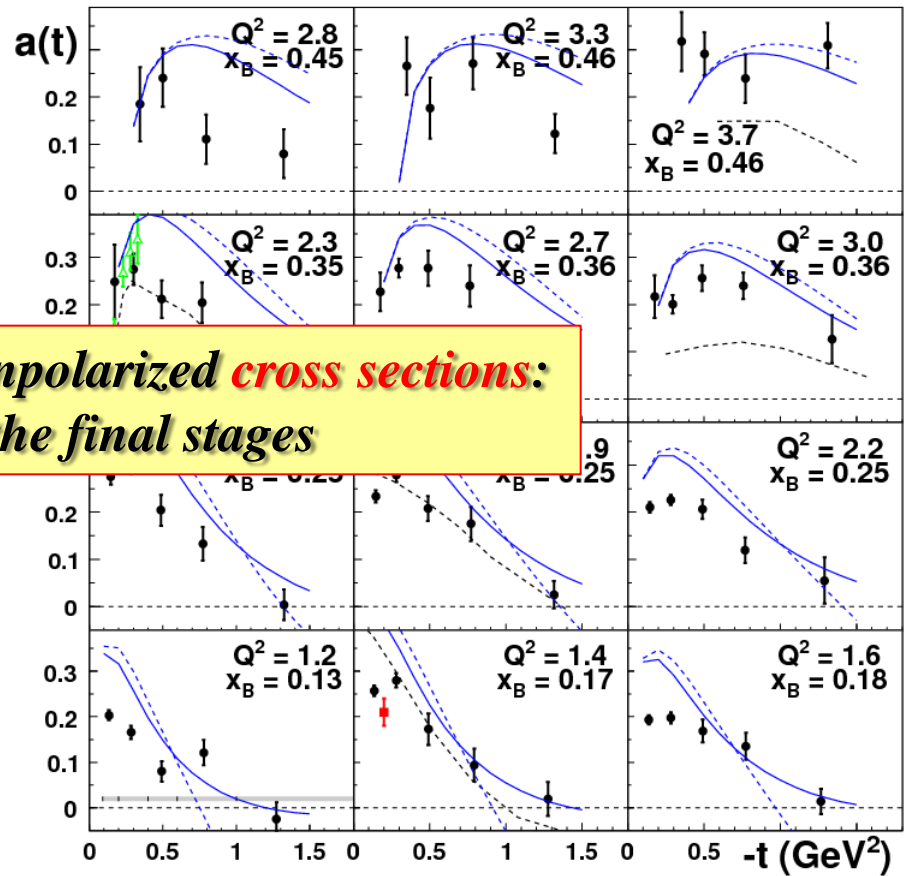

$$\text{Fit} = a \sin\phi / (1 + b \cos\phi)$$

- CLAS e1-dvcs
- ▲ Hall A
- CLAS @ 4.3 GeV²
- VGG(*) twist-2 (DD)
- - - VGG(*) twist-2 and 3
- Regge model (**)

F.X. Girod et al. (CLAS Collaboration),
Phys. Rev. Lett. 100, 162002 (2008)

(*) Guidal, Polyakov, Radyushkin,
Vanderhaegen, PRD 72 (2005)

(**) Cano and Laget, PL B551 (2003)

What we learn from the published CLAS asymmetries

CLAS
pDVCS
BSAs

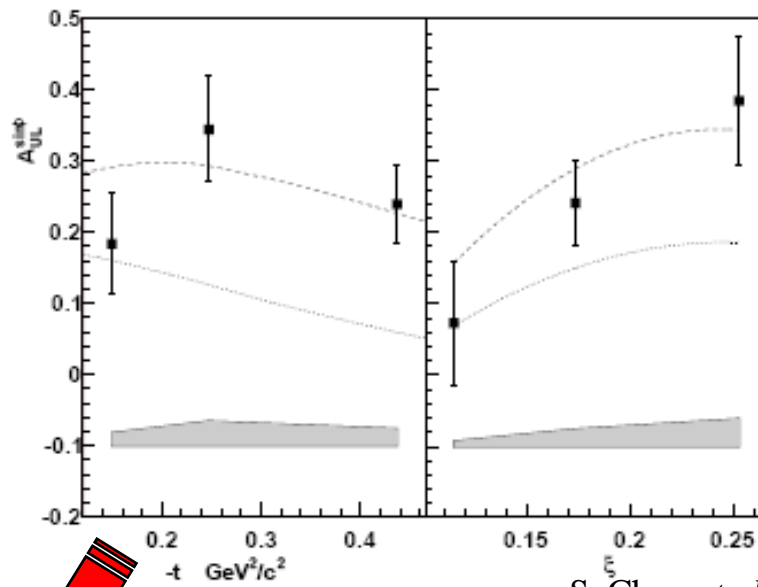
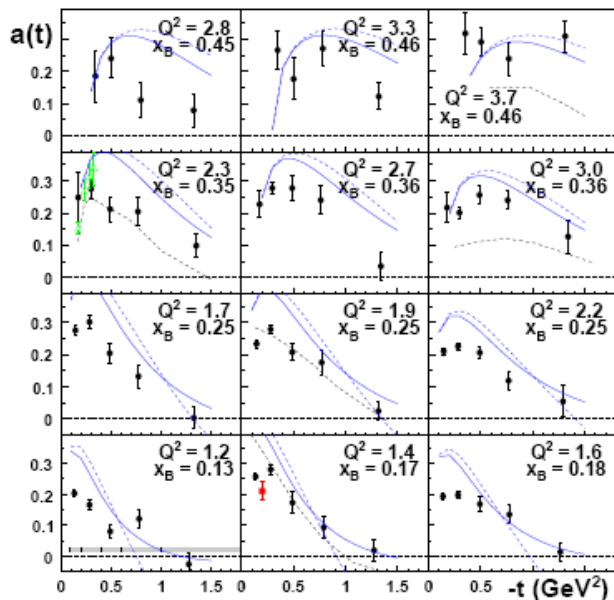

CLAS
pDVCS
TSAs

S. Chen *et al*,
PRL 97, 072002 (2006)

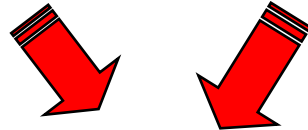

Model-independent fit
at fixed x_B, t, Q^2
of DVCS observables

ImH has steeper t -slope
than $\tilde{\text{ImH}}$: is axial charge
more concentrated than the
electromagnetic charge?

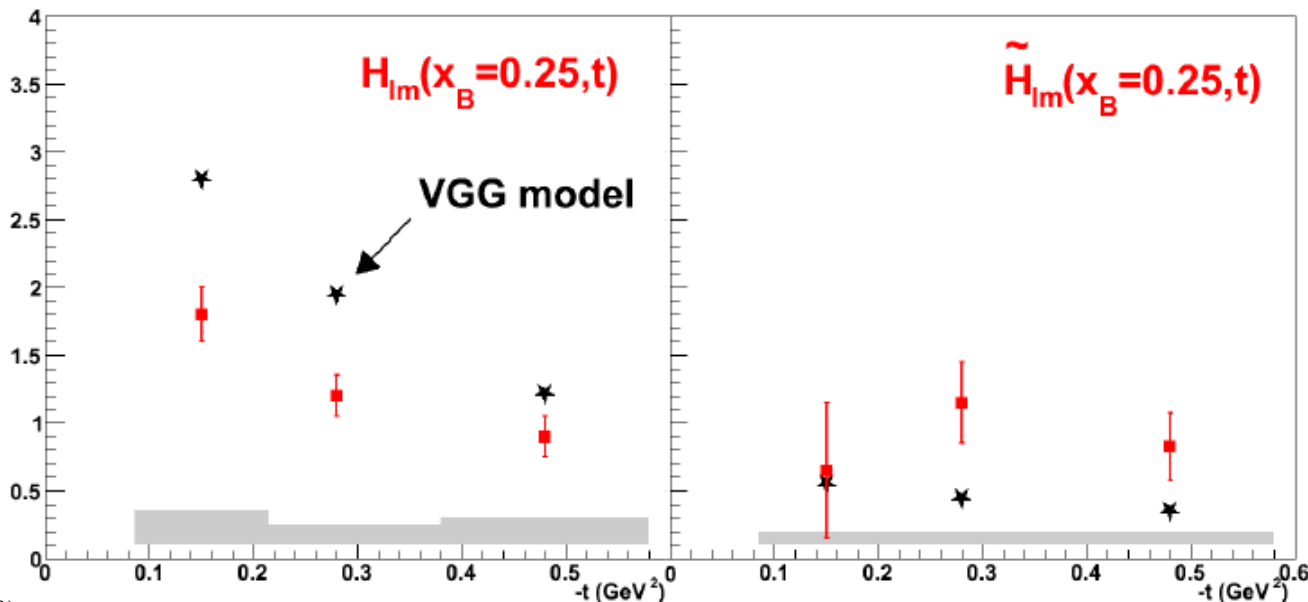

The eg1-DVCS experiment: TSA

- Data taken from February 4 to September 21 2009
- Beam energy = 4.735, 5.764, 5.892, 5.967 GeV
- Target: longitudinally polarized NH₃ (~80%) and ND₃ (~30%)
- IC to detect forward photons

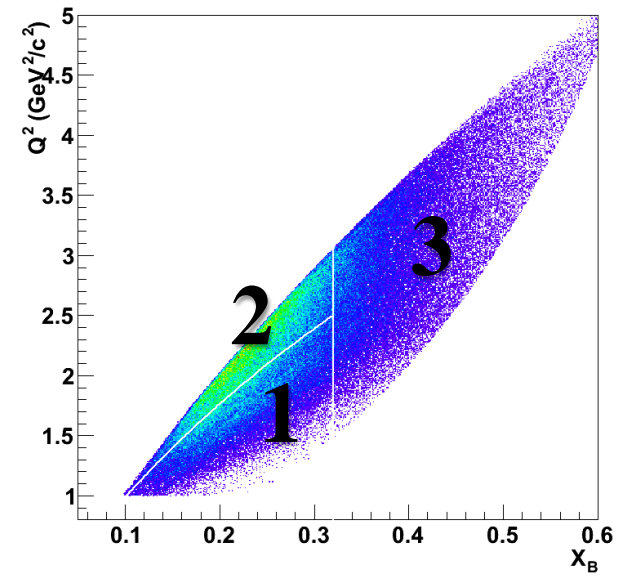
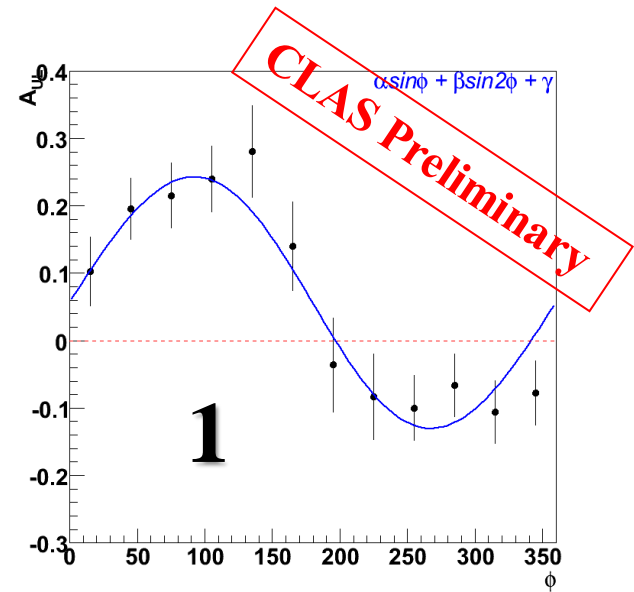
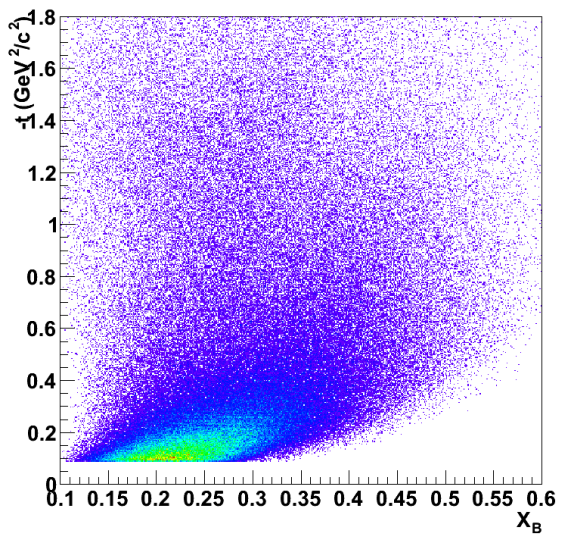
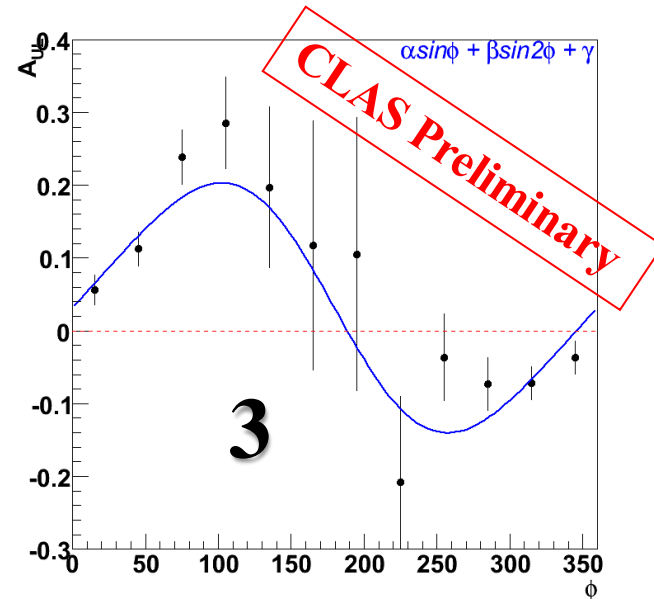
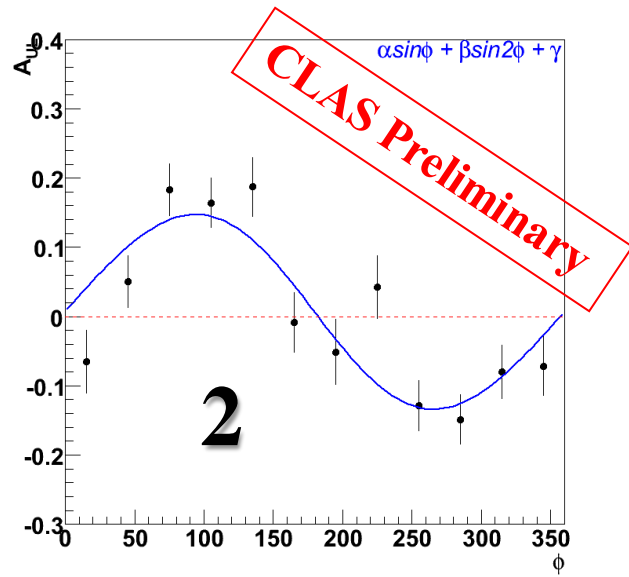

$$\Delta\sigma_{UL} \sim \sin\phi \text{Im}\{F_1 \tilde{\mathcal{H}} + \xi(F_1 + F_2)(\mathcal{H} + x_B/2E) - \xi k F_2 E + \dots\} d\phi$$

The eg1-DVCS experiment: TSA

- Data taken from February 4 to September 21 2009
- Beam energy = 4.735, 5.764, 5.892, 5.967 GeV
- Target: longitudinally polarized NH₃ (~80%) and ND₃ (~30%)
- IC to detect forward photons

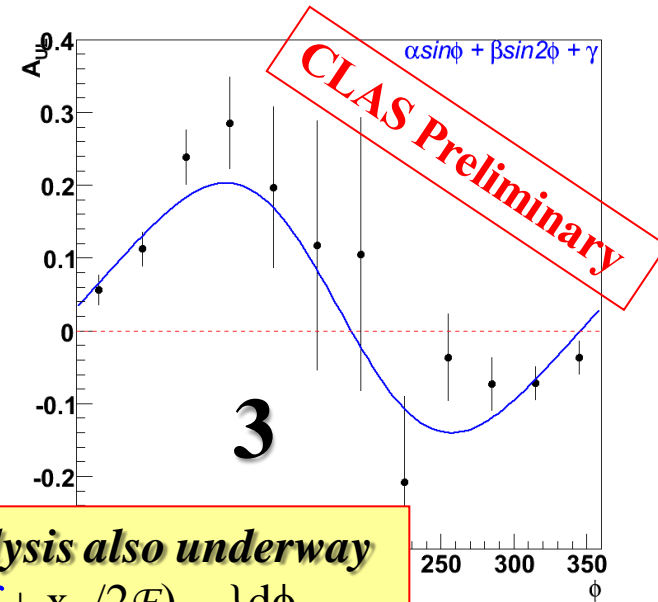
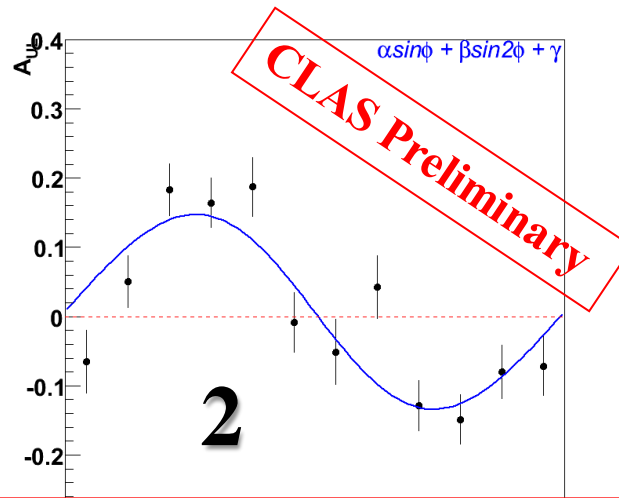

Double-spin (beam-target) asymmetry analysis also underway
 $\Delta\sigma_{LL} \sim (A+B\cos\phi)\text{Re}\{F_1\tilde{\mathcal{H}}+\xi(F_1+F_2)(\mathcal{H}+x_B/2\mathcal{E})\dots\}d\phi$

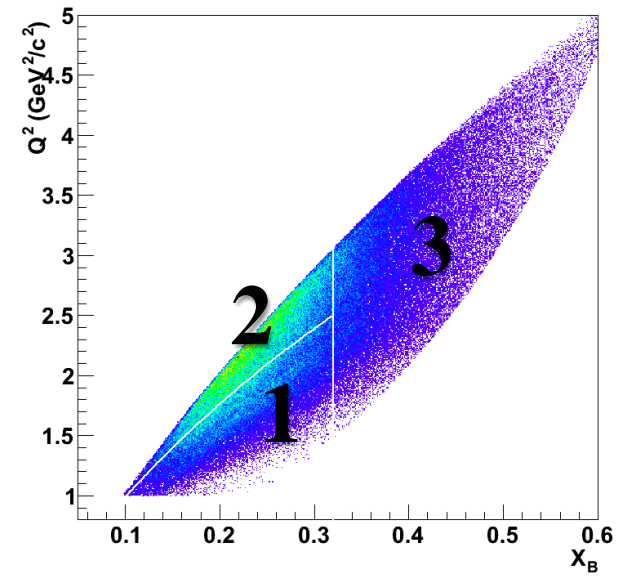
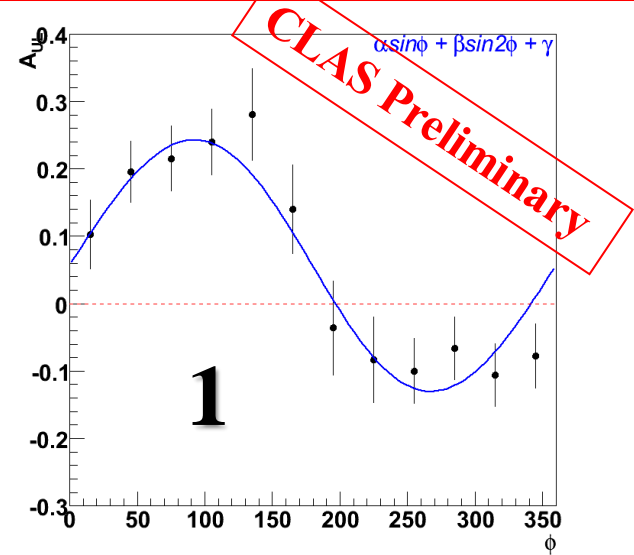
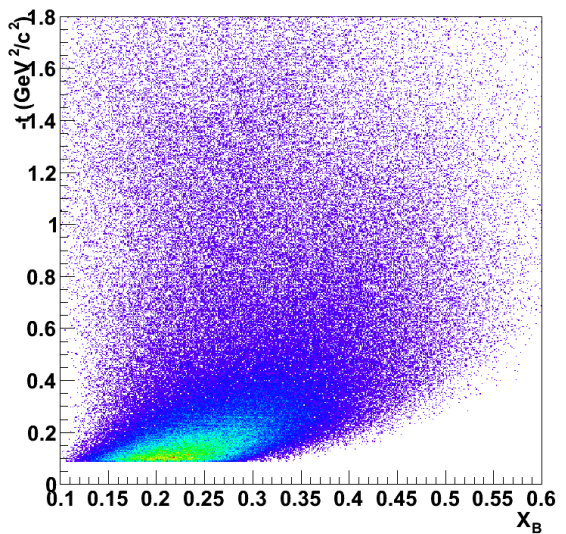

$\Delta\sigma_{UL} \sim \sin\phi\text{Im}\{F_1\tilde{\mathcal{H}}+\xi(F_1+F_2)(\mathcal{H}+x_B/2\mathcal{E})-\xi kF_2\mathcal{E}+\dots\}d\phi$

Deeply virtual meson production and GPDs

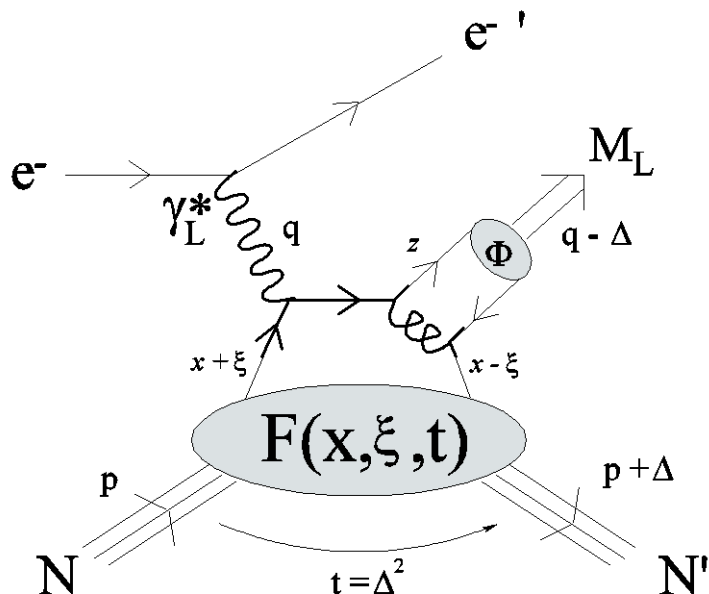

Different mesons → different sensitivity to GPDs

H
E
 ↓
Vector mesons
 (ρ, ω, ϕ)

\tilde{H}
 \tilde{E}
 ↓
Pseudoscalar mesons
 (π, η)

π^0	$2\Delta u + \Delta d$
η	$2\Delta u - \Delta d$
ρ^0	$2u + d$
ω	$2u - d$
ρ^+	$u - d$

Factorization proven only for **longitudinally polarized** virtual photons and valid at **high Q^2** and **small t**

quark flavor decomposition accessible via meson production

$$\mathcal{A}_L = -\frac{2ie}{9} \left(\int_0^1 dz \frac{\Phi(z)}{z} \right) \frac{4\pi\alpha_S(Q^2)}{Q} \int_{-1}^{+1} dx \left\{ \left[\frac{1}{x-\xi+i\epsilon} + \frac{1}{x+\xi-i\epsilon} \right] F(x, \xi, t) \right\}$$

Complications: effective scale in the hard scattering process, meson distribution amplitude

Deeply virtual meson production at CLAS

Vector mesons: exclusive ρ^0 , ω , ϕ and ρ^+ electroproduction on the proton with CLAS:

K. Lukashin *et al.*, Phys. Rev. C 63, 065205, 2001 (ϕ @4.2 GeV)

C. Hadjidakis *et al.*, Phys. Lett. B 605, 256-264, 2005 (ρ^0 @4.2 GeV)

L. Morand *et al.*, Eur. Phys. J. A 24, 445-458, 2005 (ω @5.75 GeV)

J. Santoro *et al.*, Phys. Rev. C 78, 025210, 2008 (ϕ @5.75 GeV)

S. Morrow *et al.*, Eur. Phys. J. A 39, 5-31, 2009 (ρ^0 @5.75 GeV)

A. Fradi, Orsay Univ. PhD thesis (ρ^+ @5.75 GeV)

e1-b
(1999)

e1-6
(2001-2002)

e1-DVCS
(2005)

There are also results on **exclusive pseudoscalar meson electroproduction** on the proton with CLAS:

R. De Masi *et al.*, Phys. Rev. C 77, 042201(R), 2008 (π^0 @5.75 GeV)

K. Park *et al.*, Phys. Rev. C 77, 015208, 2008 (π^+ @5.75 GeV)

I. Bedlinskiy *et al.*, paper in preparation (π^0 @5.75 GeV)

Comparison between vector mesons (σ)

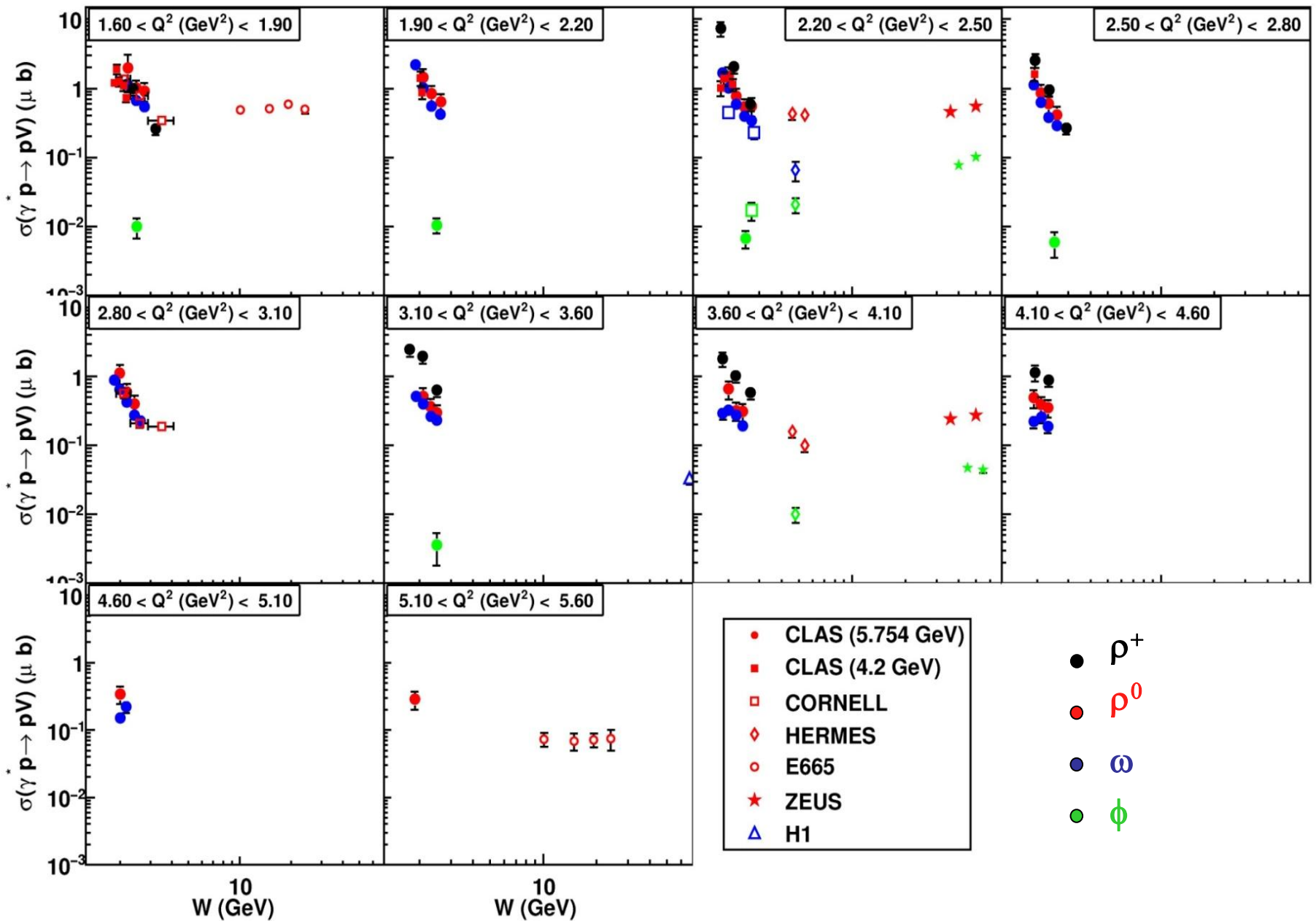

Comparison between vector mesons

b increases with W ($\sim 1/x$): valence (fast) quarks in the center and sea (slow) quarks at the periphery of the nucleon

$$d\sigma/dt \sim e^{bt}$$

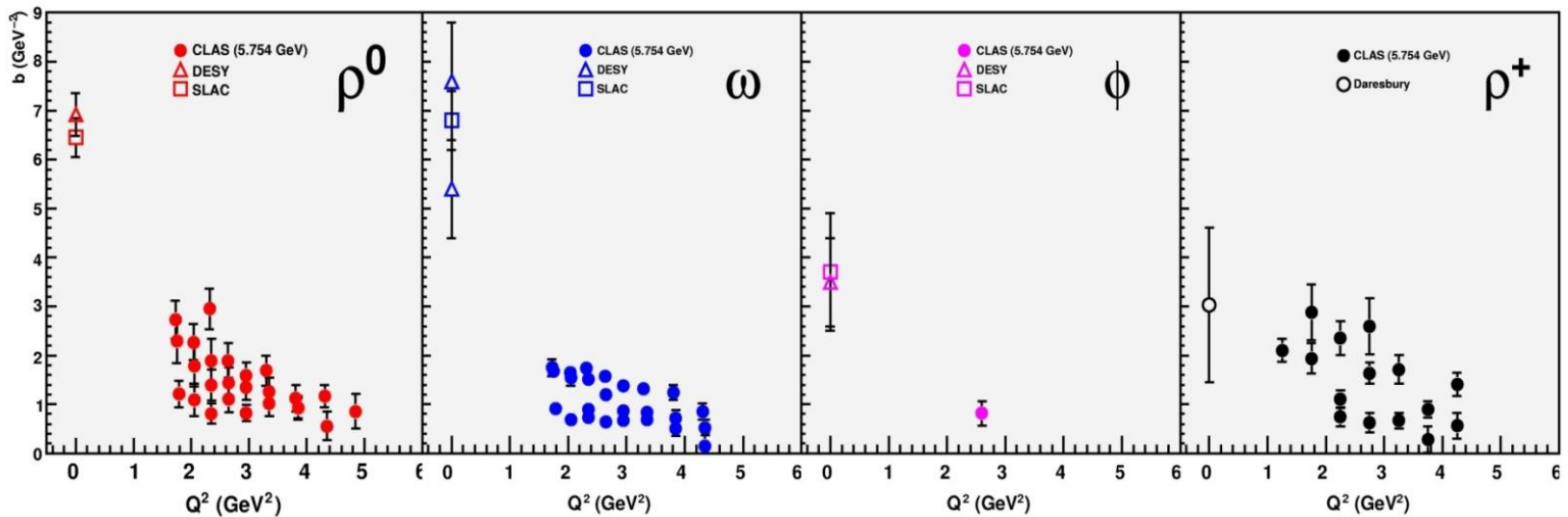
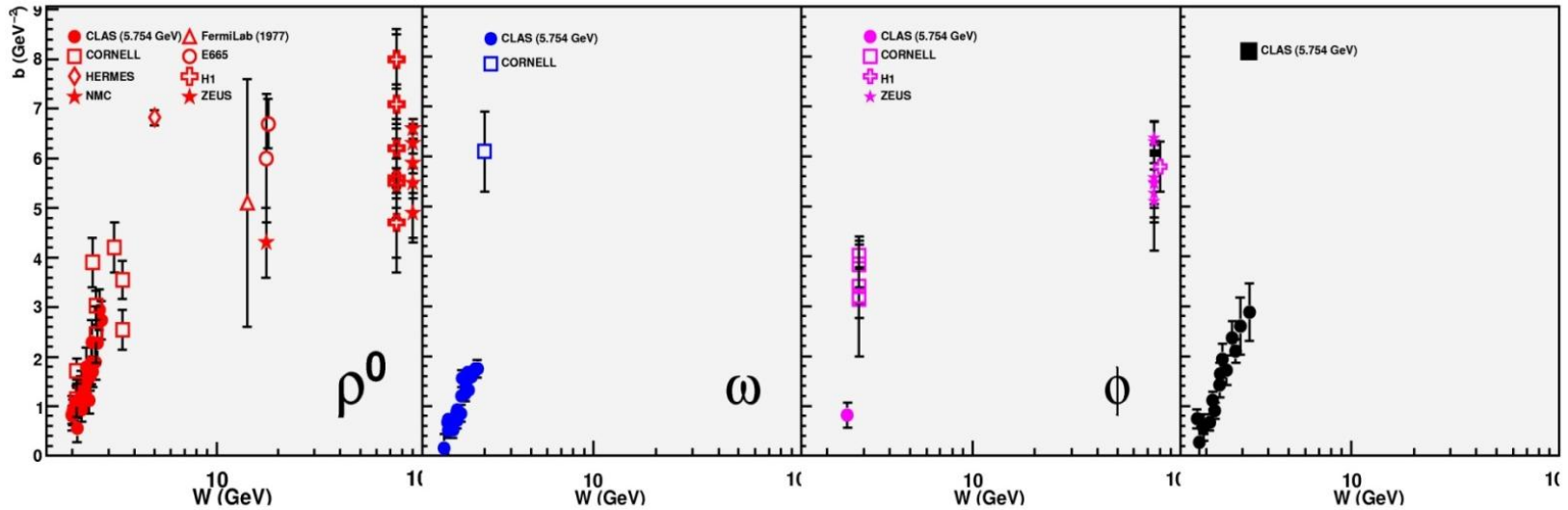

b decreases with Q^2 : by increasing the resolution of the probe, smaller objects in the nucleon can be seen

Longitudinal cross section $\sigma_L(\gamma^*_L p \rightarrow p \rho^0_L)$

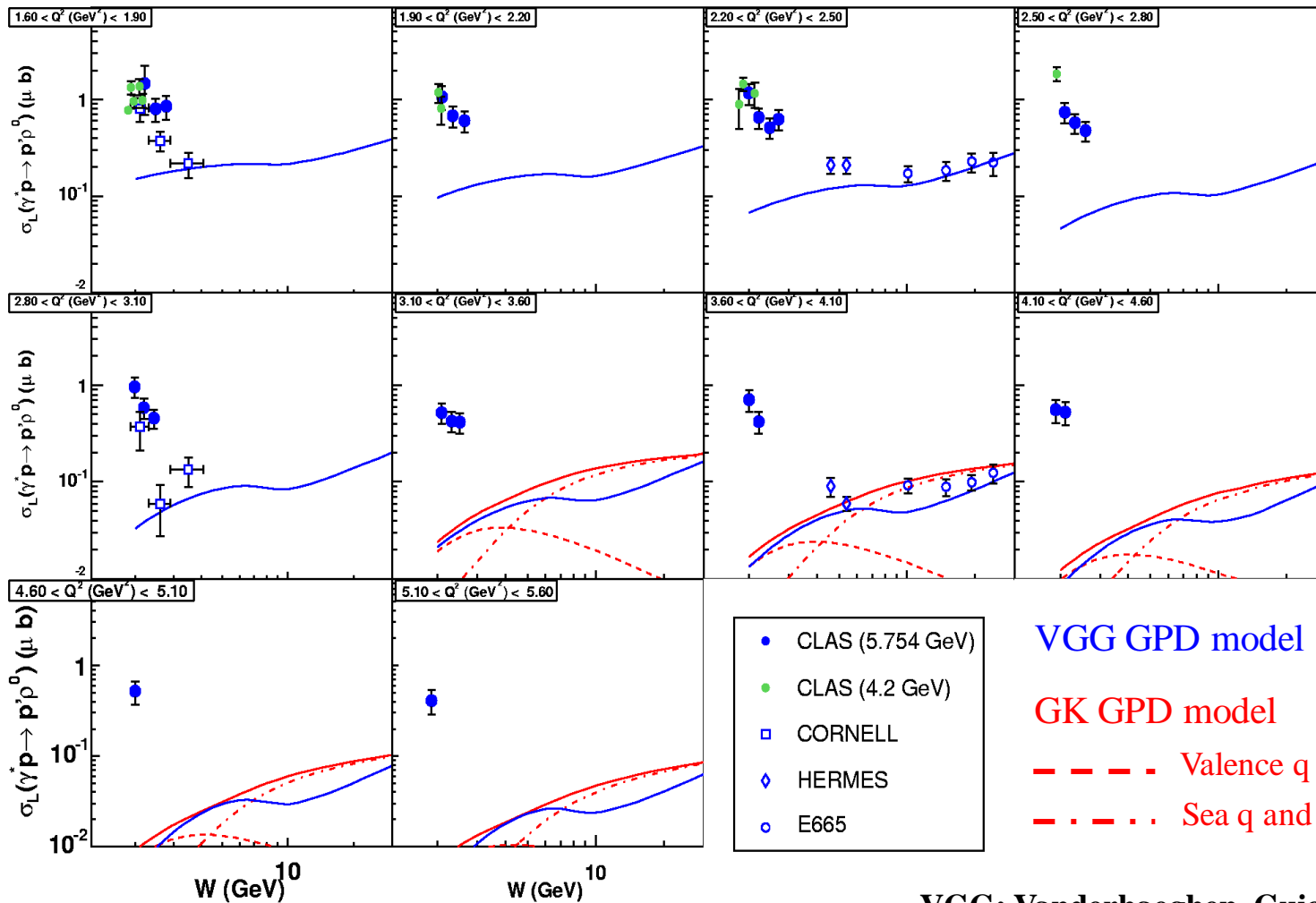

The GPD models fail to reproduce the behavior at low W (W < 5 GeV)

- CLAS (5.754 GeV)
- CLAS (4.2 GeV)
- CORNELL
- ◇ HERMES
- E665

VGG GPD model

GK GPD model

--- Valence q

- . - . Sea q and gluons

VGG: Vanderhaeghen, Guichon, Guidal

GK: Goloskokov, Kroll

GPDs: where we stand, where we are going

- Pioneering dedicated experiments on **DVCS** (Hall A, CLAS), show evidence for **handbag (twist-2) dominance** (asymmetry $\sim \sin\phi$) and **unexpected scaling** at $Q^2 \sim 2 \text{ GeV}^2$ (Hall A)
- **DVMP** experiments at CLAS (ρ , ω , π^0) and Hall A (π^0) hint that either **scaling cannot be reached** for Q^2 as low as for DVCS or **something is missing** in GPDs parameterizations
- Model-independent fits need to combine **several observables** to constrain GPDs
- Hall A's first attempt to measure **nDVCS** showed the importance of this channel for **Ji's sum rule** and the extraction of J_q

More data needed on DVCS and DVMP:

- **High Q^2** to verify scaling for DVCS on a wider Q^2 range, and to approach GPD validity regime for DVMP
- **Wide x_B coverage**
- **High accuracy** on measured observables to test models (**high luminosity** required)
- Measurements of **spin-asymmetries** and **cross sections** on proton and neutron

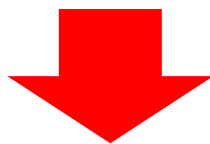

CLAS12 will be the optimal facility for these goals

JLab upgrade to 12 GeV

Continuous
Electron
Beam
Accelerator
Facility

$E = 2.2, 4.4, 6.6,$
 $8.8, 11 \text{ GeV}$
Beam polarization
 $P_e > 80\%$

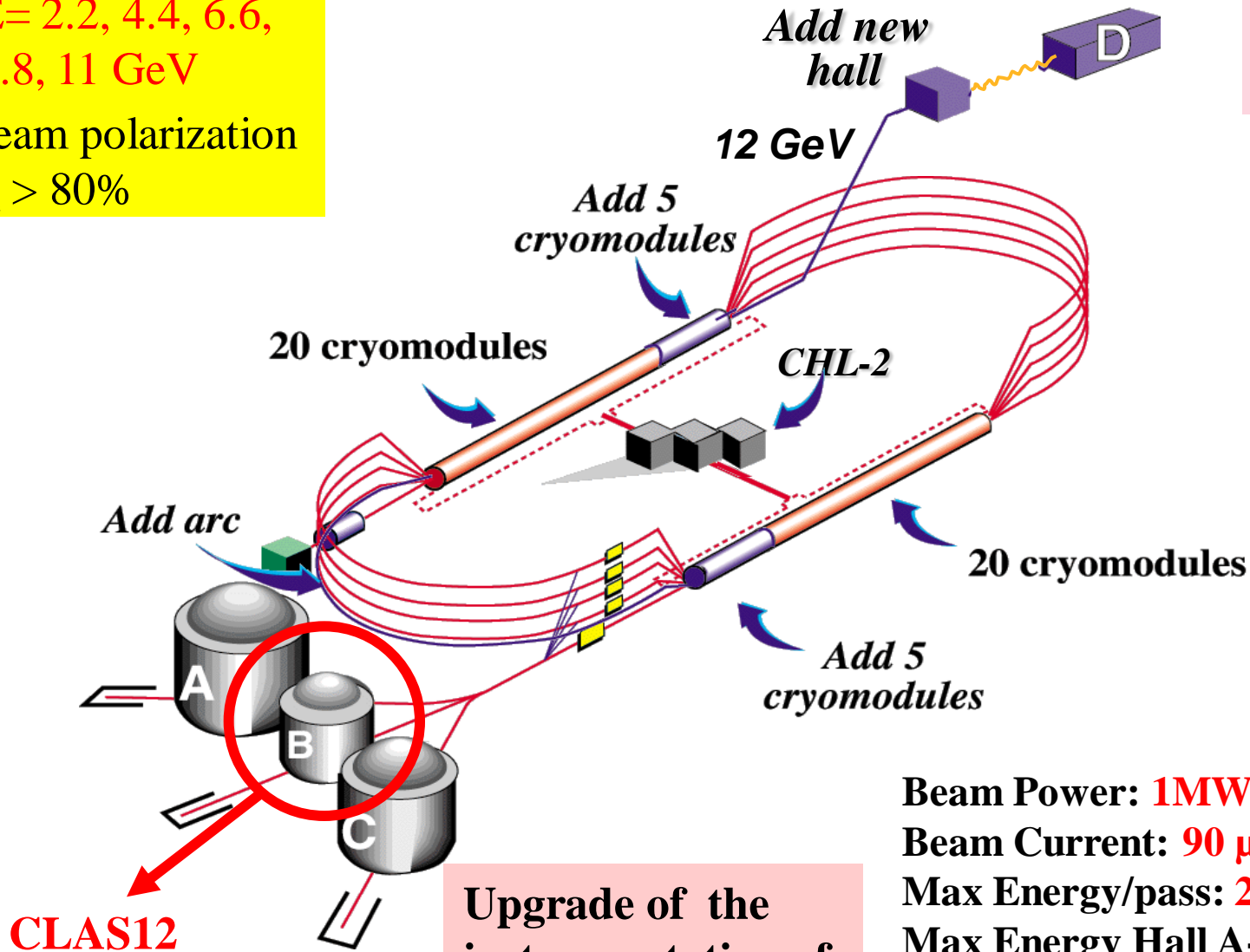

Beam Power: **1MW**
Beam Current: **90 μA**
Max Energy/pass: **2.2 GeV**
Max Energy Hall A-C: **11 GeV**
Max Energy Hall D: **12 GeV**

Upgrade of the
instrumentation of
the existing Halls

Hall B @ 12 GeV: CLAS12

Design luminosity
 $L \sim 10^{35} \text{ cm}^{-2}\text{s}^{-1}$

Acceptance for
charged particles:

- Central (CD), $40^\circ < \theta < 135^\circ$
- Forward (FD), $5^\circ < \theta < 40^\circ$

Acceptance for photons:

- IC $2^\circ < \theta < 5^\circ$
- EC, $5^\circ < \theta < 40^\circ$

**High luminosity & large
acceptance:**

Concurrent measurement
of deeply virtual **exclusive**,
semi-inclusive,
and **inclusive** processes

Central
Detector

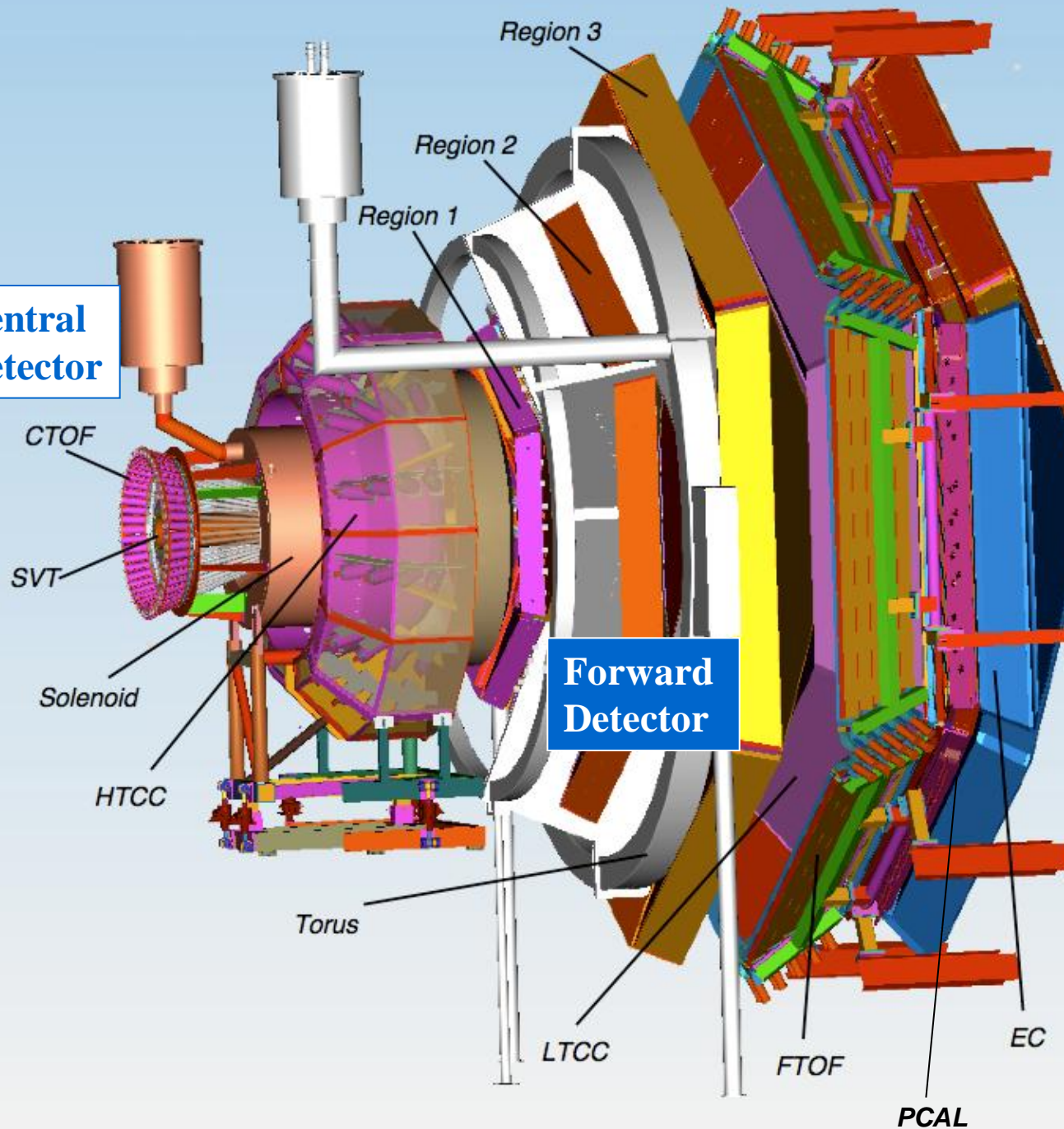

Hall B @ 12 GeV: CLAS12

Forward Detector:

- TORUS magnet
- Forward tracker
- HT Cherenkov Counter
- Drift chambers (3 regions)
- LT Cherenkov Counter
- Forward ToF System
- Preshower calorimeter
- E.M. calorimeter (EC)
- Inner Calorimeter (IC, not shown)

Central Detector:

- SOLENOID magnet
- Barrel Silicon Tracker
- Central Time-of-Flight

Proposed upgrades:

- Micromegas (CD)
- Neutron detector (CD)
- RICH detector (FD)
- Forward Tagger (FD)

Central
Detector

Forward
Detector

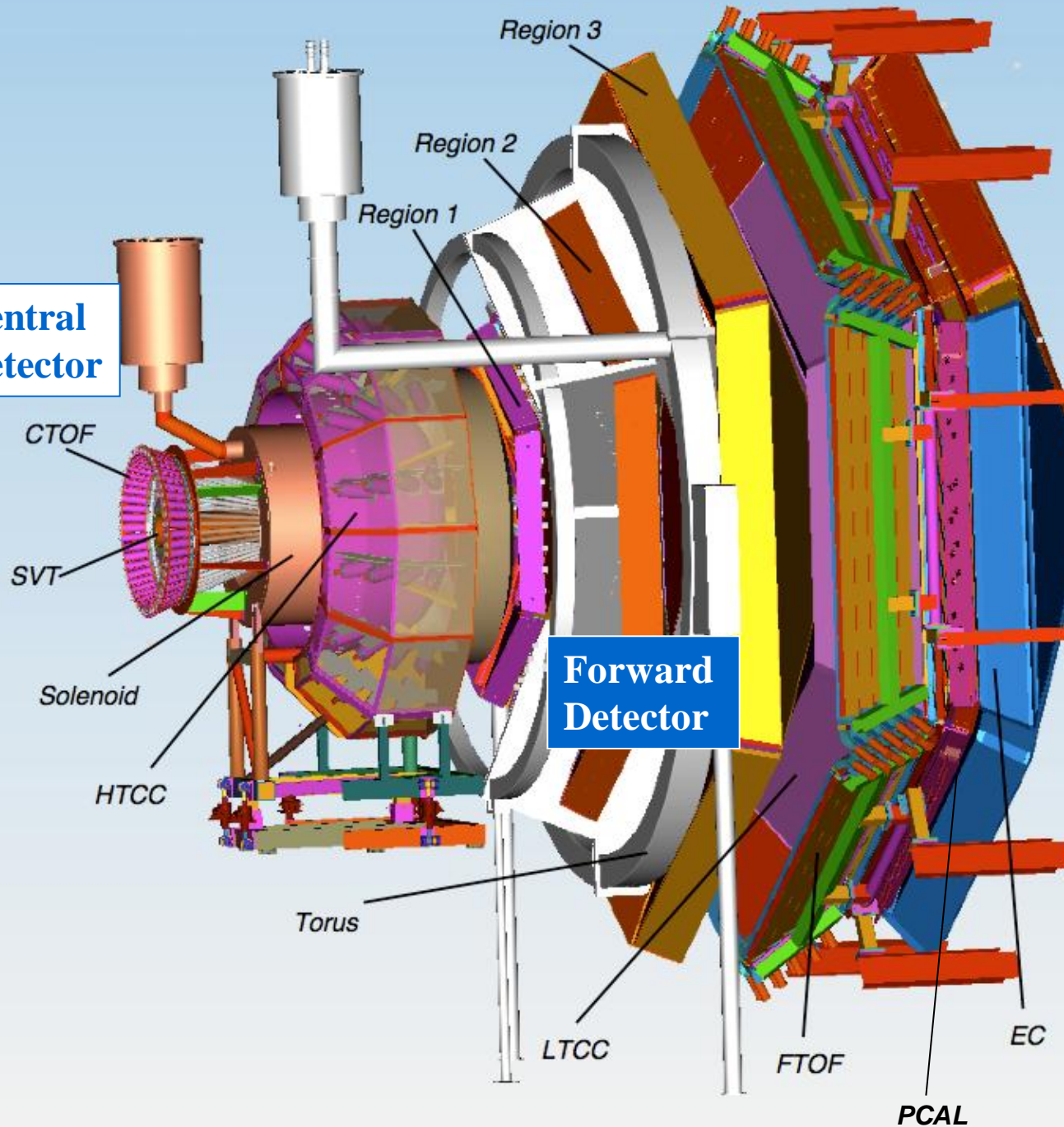

Large phase space (ξ, t, Q^2) and high luminosity

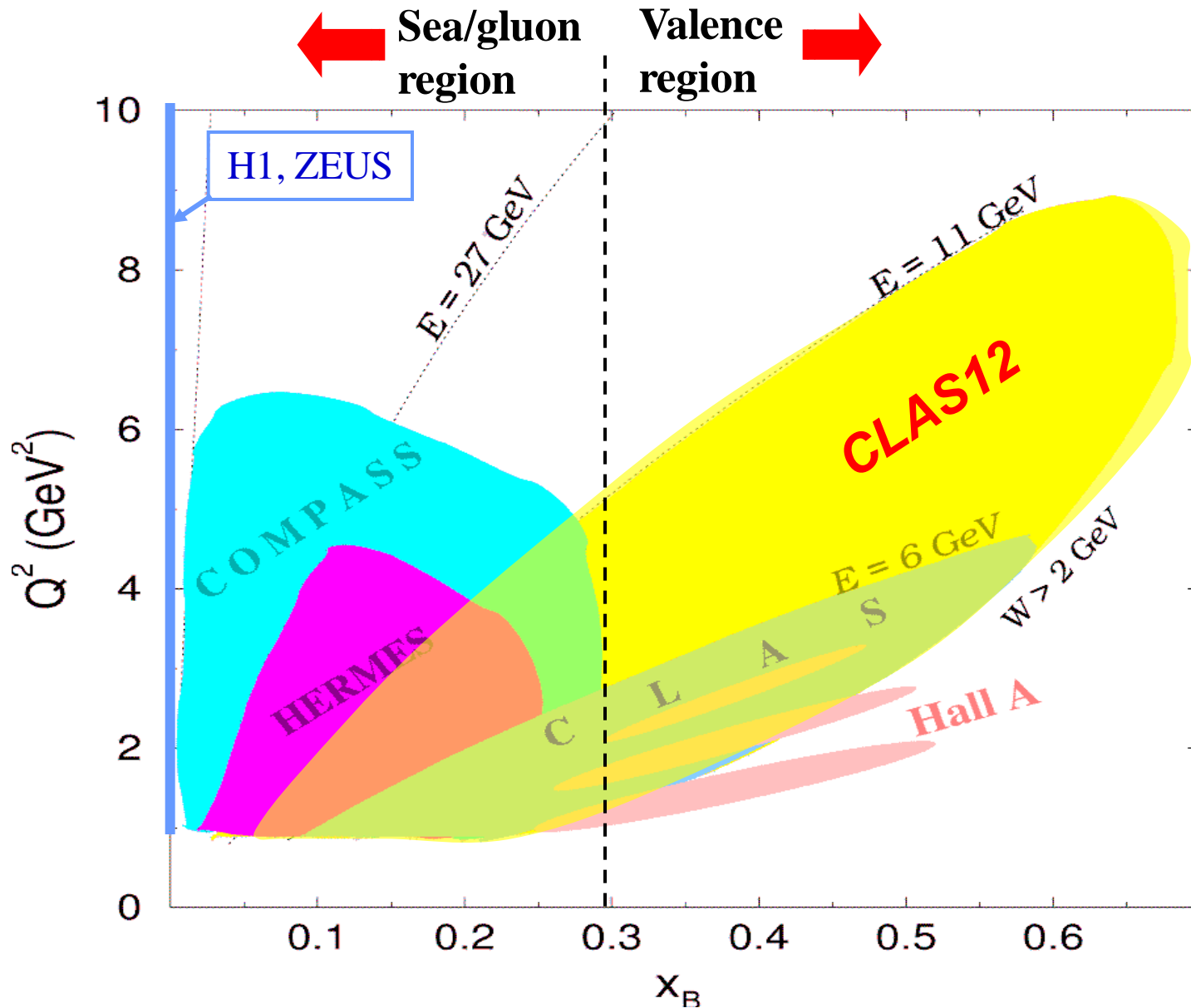

DVCS BSA and TSA with CLAS12 & 11 GeV beam

85 days of beam time

$P_{\text{beam}} = 85\%$

$L = 10^{35} \text{ cm}^{-2}\text{s}^{-1}$

$1 < Q^2 < 10 \text{ GeV}^2$

$0.1 < x_B < 0.65$

$-t_{\text{min}} < -t < 2.5 \text{ GeV}^2$

Statistical error: 1% to 10%

on $\sin\phi$ moments

Systematic uncertainties: ~6-8%

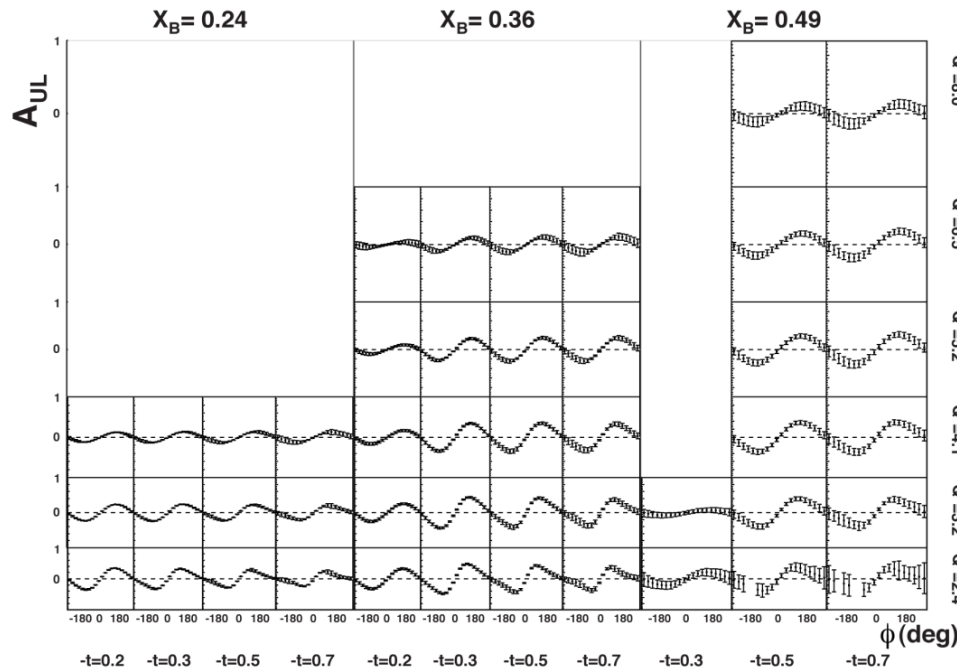
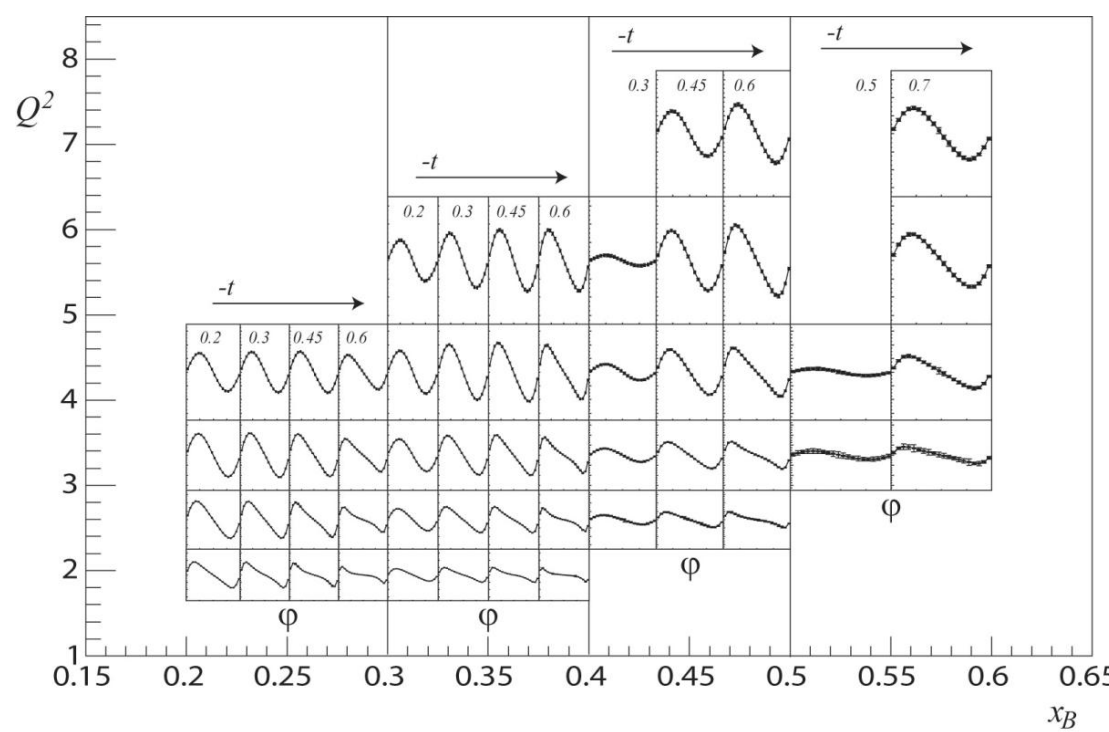

120 days of beam time

$P_{\text{beam}} = 85\%$, $P_{\text{target}} = 80\%$

$L = 2.10^{35} \text{ cm}^{-2}\text{s}^{-1}$

$1 < Q^2 < 10 \text{ GeV}^2$

$0.1 < x_B < 0.65$

$-t_{\text{min}} < -t < 2.5 \text{ GeV}^2$

Statistical error: 2% to 15%

on $\sin\phi$ moments

Systematic uncertainties: ~6-8%

DVCS BSA and TSA with CLAS12 & 11 GeV beam

85 days of beam time

$P_{\text{beam}} = 85\%$

$L = 10^{35} \text{ cm}^{-2}\text{s}^{-1}$

$1 < Q^2 < 10 \text{ GeV}^2$

$0.1 < x_B < 0.65$

$-t_{\text{min}} < -t < 2.5 \text{ GeV}^2$

Statistical error: 1% to 10%

on $\sin\phi$ moments

Systematic uncertainties: $\sim 6\text{-}8\%$

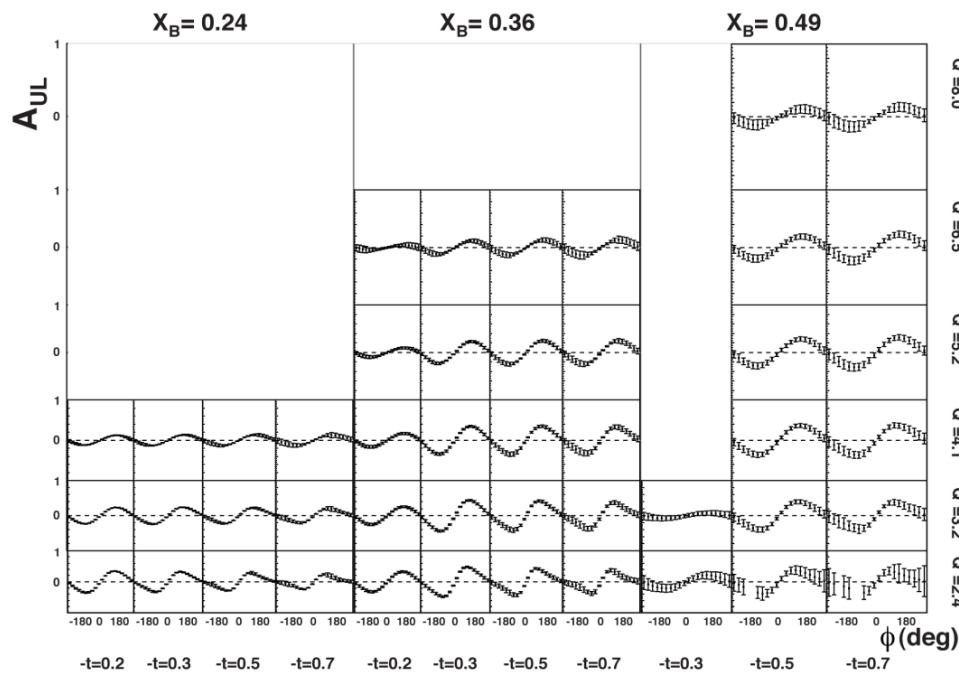
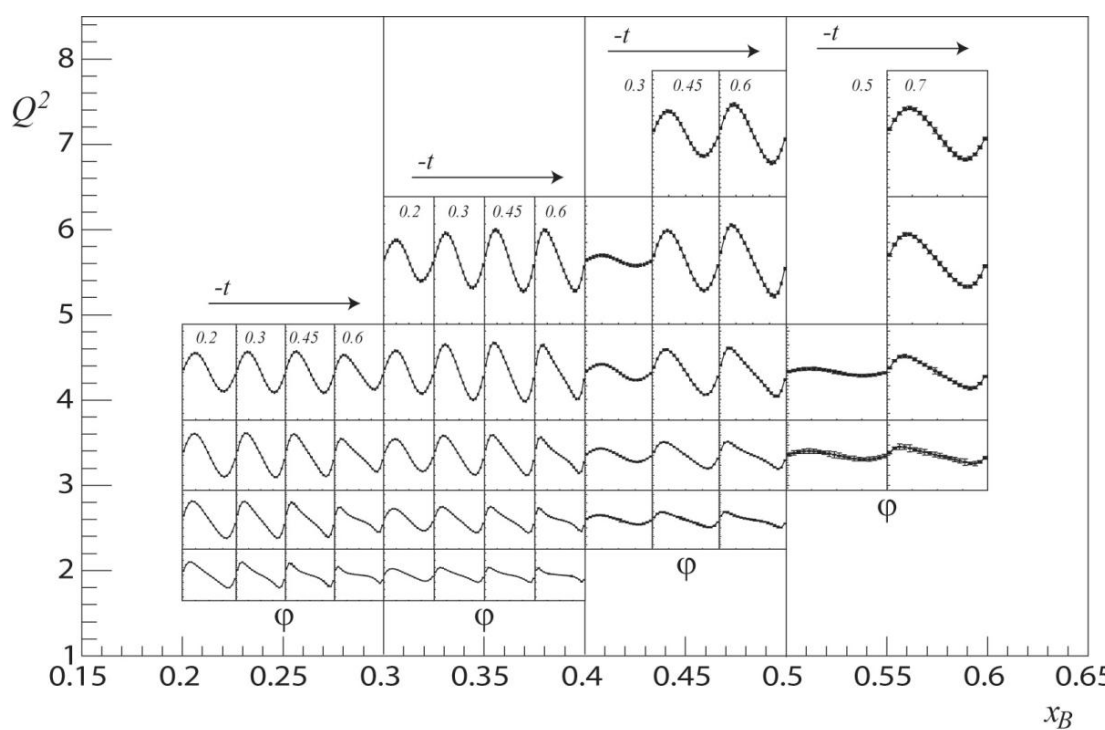

Impact of CLAS12 DVCS-BSA data on model-independent fit to extract $\text{Im}(H)$

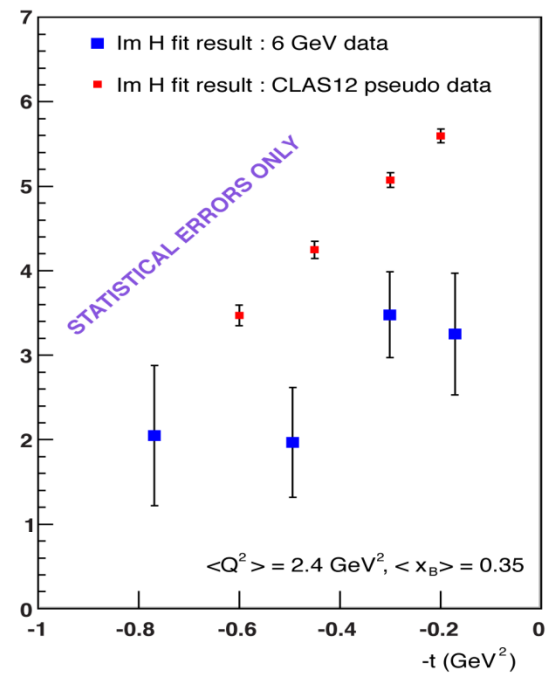

BSA for DVCS on the neutron with CLAS12

$$(H, E)_u(\xi, \xi, t) = \frac{9}{15} [4(H, E)_p(\xi, \xi, t) - (H, E)_n(\xi, \xi, t)]$$

$$(H, E)_d(\xi, \xi, t) = \frac{9}{15} [4(H, E)_n(\xi, \xi, t) - (H, E)_p(\xi, \xi, t)]$$

$$\Delta\sigma_{\text{LU}} \sim \sin\phi \operatorname{Im}\{F_1\mathcal{H} + \xi(F_1+F_2)\tilde{\mathcal{H}} - kF_2\mathcal{E}\}d\phi$$

The most sensitive observable to the GPD \mathcal{E}

$ed \rightarrow e(p)n\gamma$

CLAS12 +
Forward Calorimeter +
Neutron Detector

80 days of data taking
 $L = 10^{35} \text{ cm}^{-2}\text{s}^{-1}/\text{nucleon}$

First-time measurement

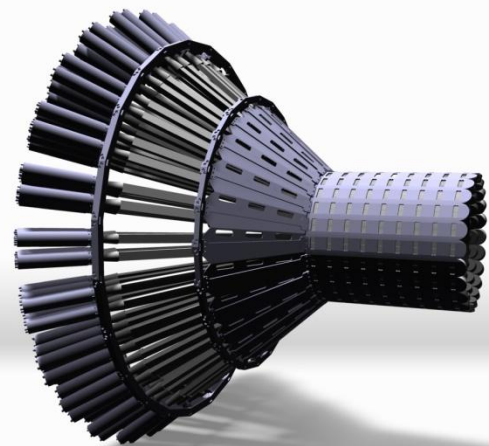
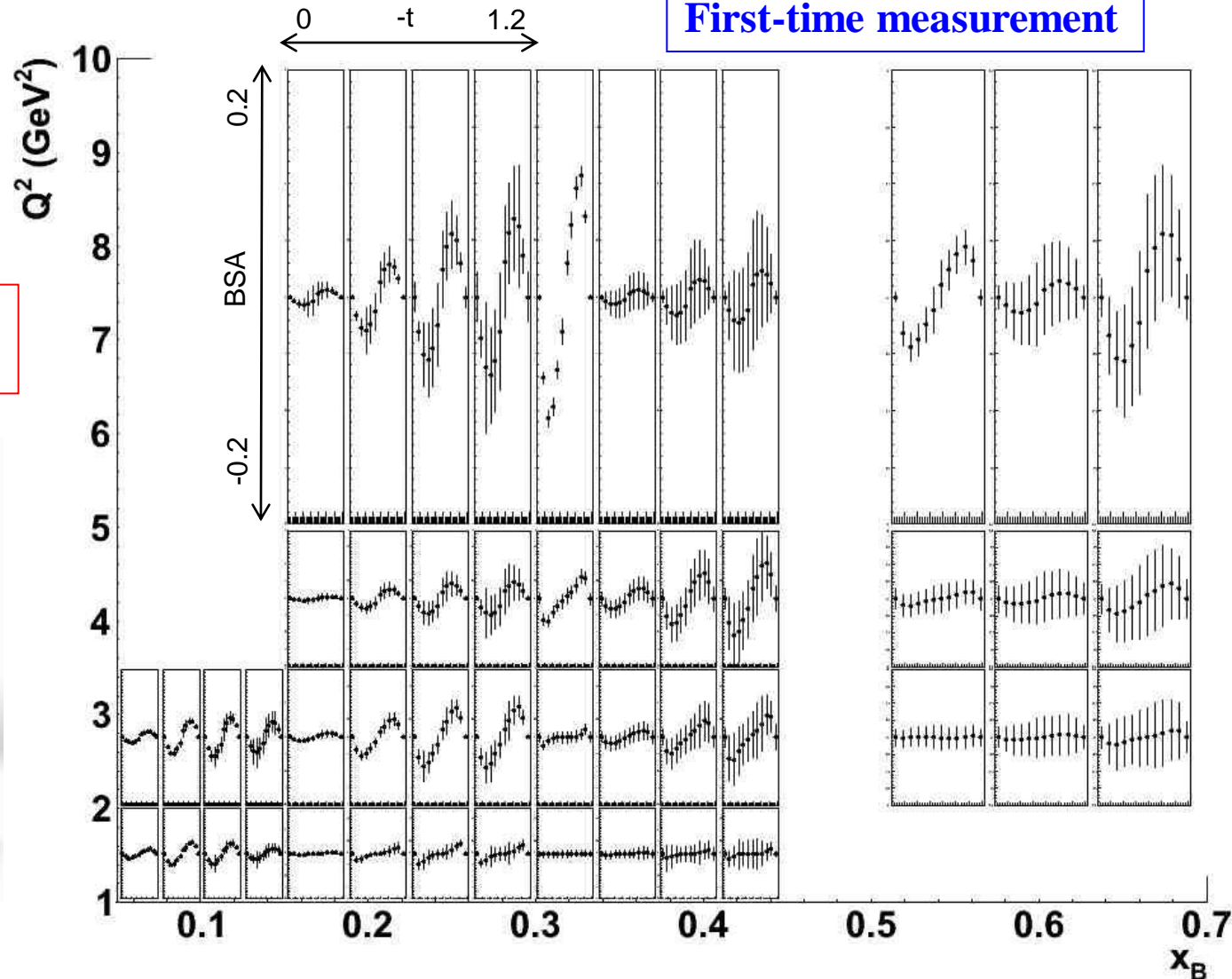

Under construction
at IPN Orsay

BSA for DVCS on the neutron with CLAS12

$$(H, E)_u(\xi, \xi, t) = \frac{9}{15} [4(H, E)_p(\xi, \xi, t) - (H, E)_n(\xi, \xi, t)]$$

$$(H, E)_d(\xi, \xi, t) = \frac{9}{15} [4(H, E)_n(\xi, \xi, t) - (H, E)_p(\xi, \xi, t)]$$

$$\Delta\sigma_{\text{LU}} \sim \sin\phi \operatorname{Im}\{F_1\mathcal{H} + \xi(F_1+F_2)\tilde{\mathcal{H}} - kF_2\mathcal{E}\} d\phi$$

The most sensitive observable to the GPD \mathcal{E}

$$ed \rightarrow e(p)\gamma$$

CLAS12 +
Forward Calorimeter +
Neutron Detector

80 days of data taking
 $L = 10^{35} \text{ cm}^{-2}\text{s}^{-1}/\text{nucleon}$

Model predictions (VGG)
for different values of
quarks' angular momentum

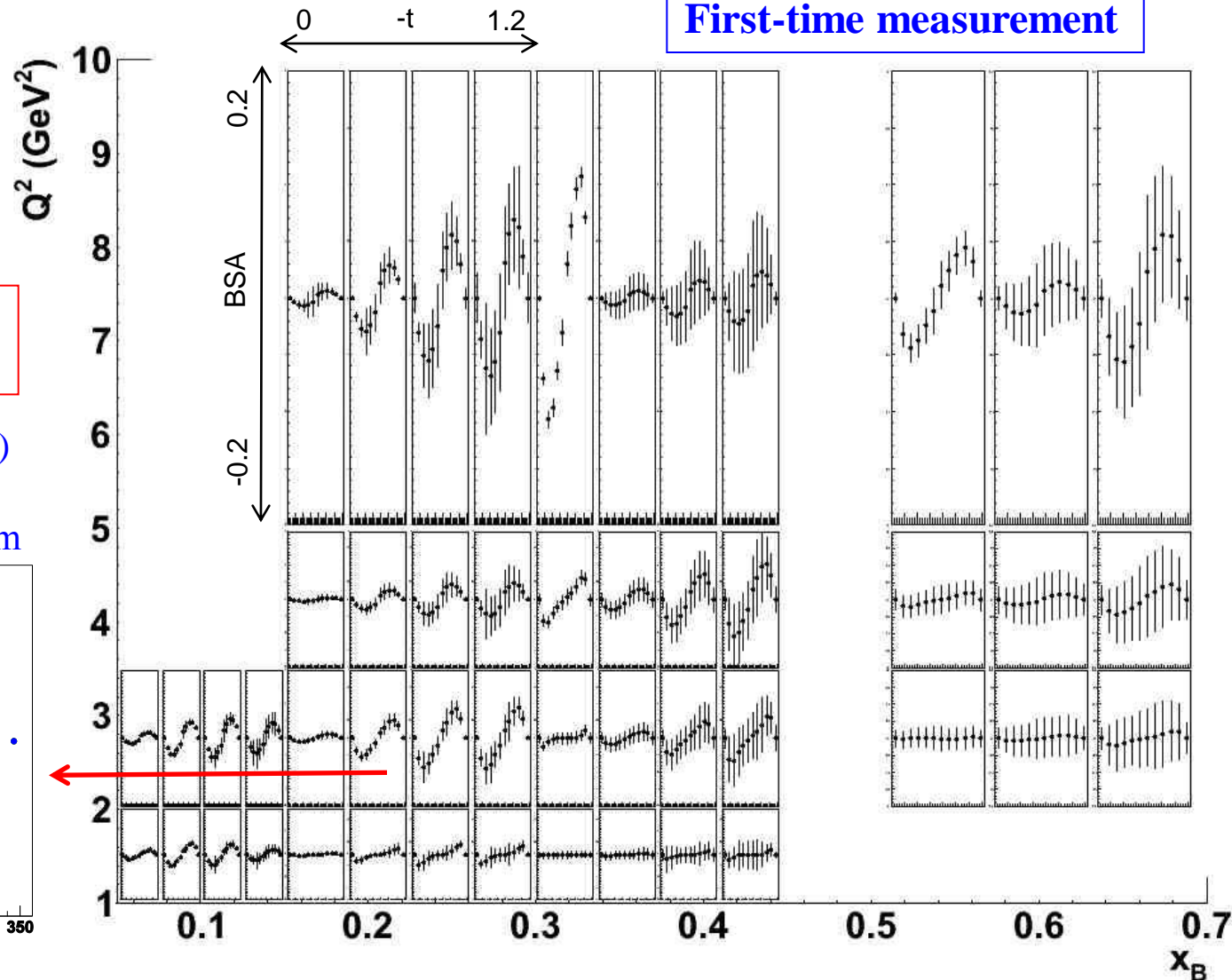
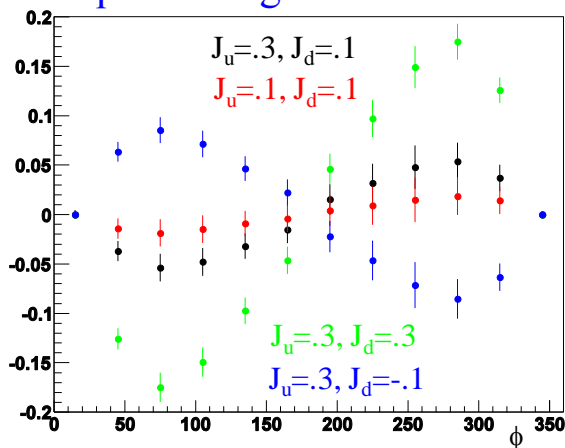

CLAS12: DVCS *transverse* target-spin asymmetry

$$e p^\uparrow \longrightarrow e p \gamma$$

E = 11 GeV

Projected results

Transversely polarized target

$$\Delta\sigma \sim \sin\phi \operatorname{Im}\{k_1(F_2\mathcal{H} - F_1\mathcal{E}) + \dots\} d\phi$$

A_{UTx} Target polarization in scattering plane

A_{UTy} Target polarization perpendicular to scattering plane

Transverse-target spin asymmetry is **highly sensitive** to the **u-quark contributions** to proton spin.

Transversely polarized target not part of CLAS12 base equipment. **R&D underway**
LOI approved by PAC38

$Q^2=2.2 \text{ GeV}^2, x_B=0.25, -t=0.5 \text{ GeV}^2$

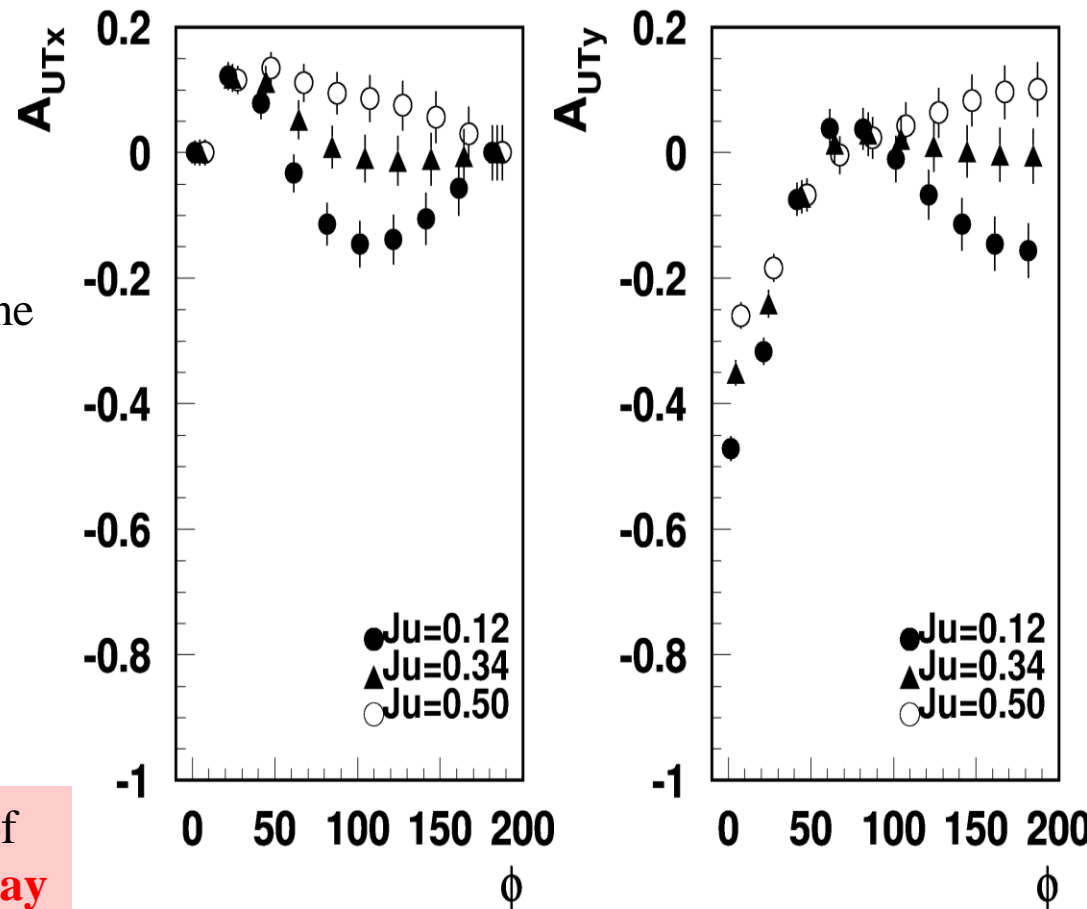

CLAS12: DVCS *transverse* target-spin asymmetry

$$e p^\uparrow \longrightarrow e p \gamma$$

E = 11 GeV

Projected results

Transversely polarized target

$$\Delta\sigma \sim \sin\phi \operatorname{Im}\{k_1(F_2\mathcal{H} - F_1\mathcal{E}) + \dots\} d\phi$$

A_{UTx} Target polar
 A_{UTy} Target polar
 scattering plane

...and CLAS12 will allow us to measure also DVCS polarized and unpolarized cross sections, vector and pseudo-scalar meson electroproduction...

Transverse-target spin asymmetry is highly sensitive to the **u-quark contributions** to proton spin.

Transversely polarized target not part of CLAS12 base equipment. **R&D underway**
LOI approved by PAC38

$Q^2=2.2 \text{ GeV}^2, x_B = 0.25, -t = 0.5 \text{ GeV}^2$

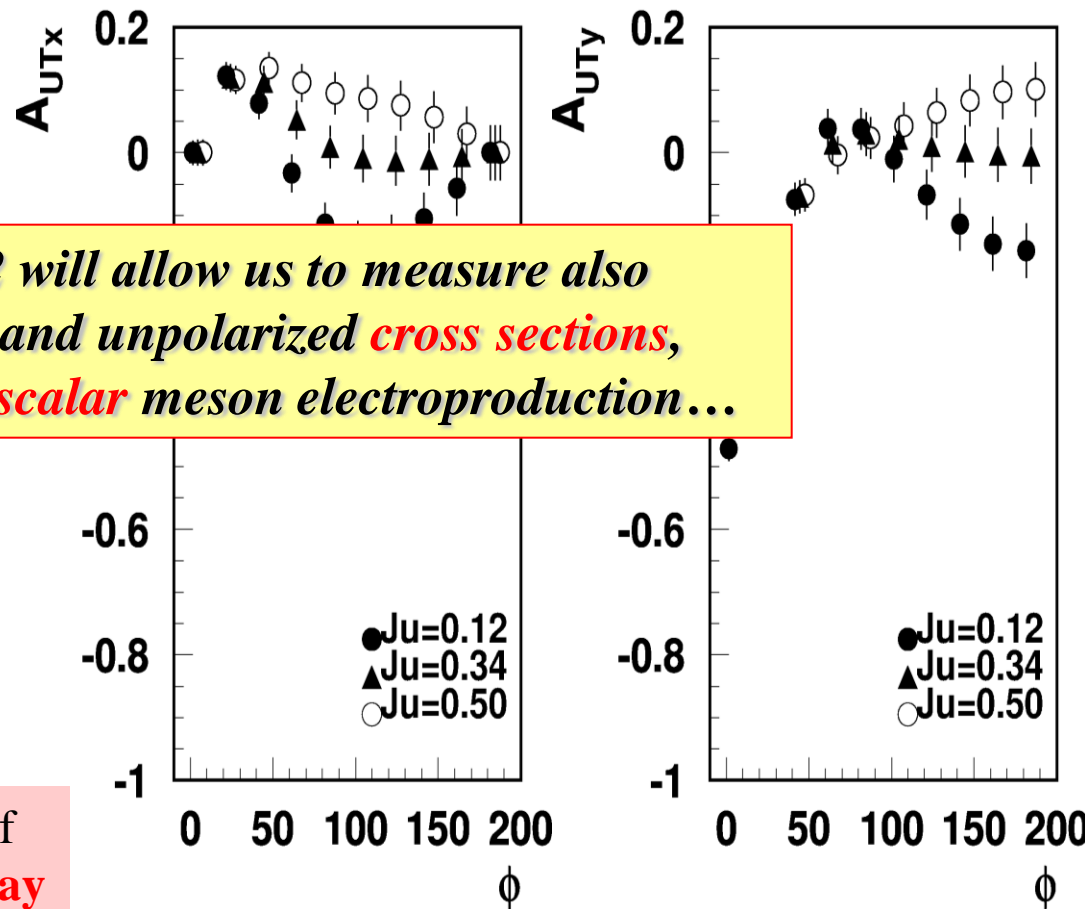

Summary

- GPDs are a unique tool to explore the **internal landscape of the nucleon**:
 - **3D** quark/gluon **imaging** of the nucleon
 - **orbital angular** momentum carried by quarks
- Their extraction from experimental data is **very difficult**:
 - they depend on **3 variables**, only two (ξ , t) experimentally accessible
 - they appear as **integrals** in cross sections
- We need to measure **several exclusive channels and observables** over a **wide phase space** to constrain the parametrizations of GPDs
- Very promising **experimental results** on DVCS and DVMP are coming from **CLAS**:
 - first **constraints on GPD models**
 - first **model-independent GPD fits**
- The JLab 12 GeV upgrade is essential for the study of **3-D nucleon structure** in the **valence region** with high precision, allowing the measurement of **deeply virtual exclusive processes** (to access GPDs) with polarized beam and polarized targets
- **CLAS12** will be world wide **the only full acceptance**, general purpose detector for **high luminosity** electron scattering experiments, and it will be perfectly suited for the **GPD program**
- The first 11 GeV electron beam will hit the CLAS12 target at the **end of 2014**