

NEW PERSPECTIVES FOR STUDY OF CHARMONIUM AND EXOTICS
ABOVE $D\bar{D}$ THRESHOLD

Barabanov M.Yu., Vodopyanov A.S.

*Veksler-Baldin Laboratory of High Energy Physics
Joint Institute for Nuclear Research
Dubna, Moscow region, Russia*

WHY WE CONCENTRATE ON PHYSICS WITH ANTIPROTONS:

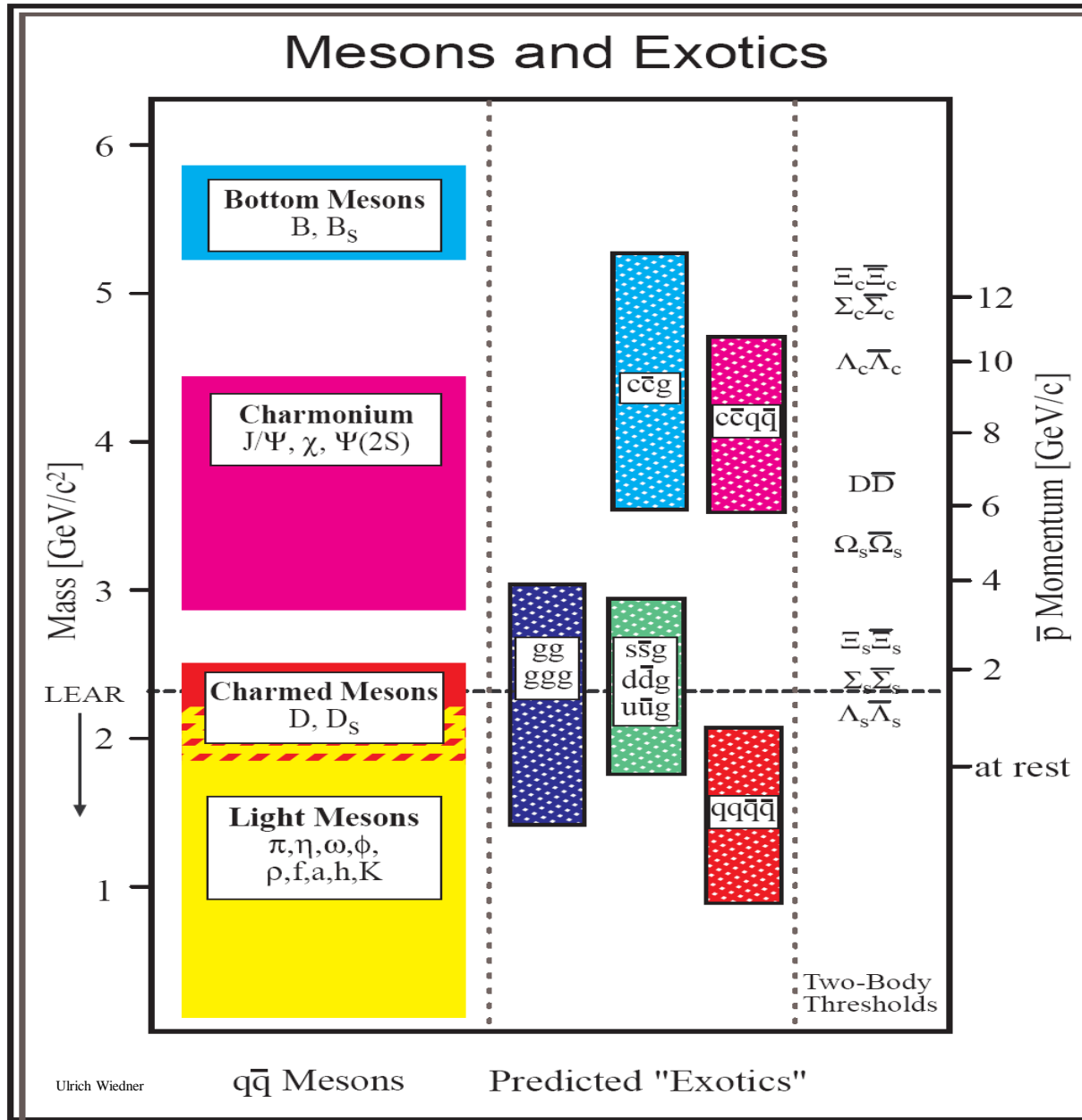

Expected masses of $q\bar{q}$ -mesons, glueballs, hybrids and two-body production thresholds.

Antiprotons accumulated in the High Energy Storage Ring HESR will collide with the fixed internal hydrogen or nuclear target. A beam luminosity of an order of $2 \times 10^{32} \text{sm}^{-2} \text{c}^{-1}$ and momentum resolution $\sigma(p)/p$ of an order of 10^{-5} are expected. The scientists from different countries intend to do fundamental research on various topics around the weak, electromagnetic and strong forces, exotic states of matter and the structure of hadrons.

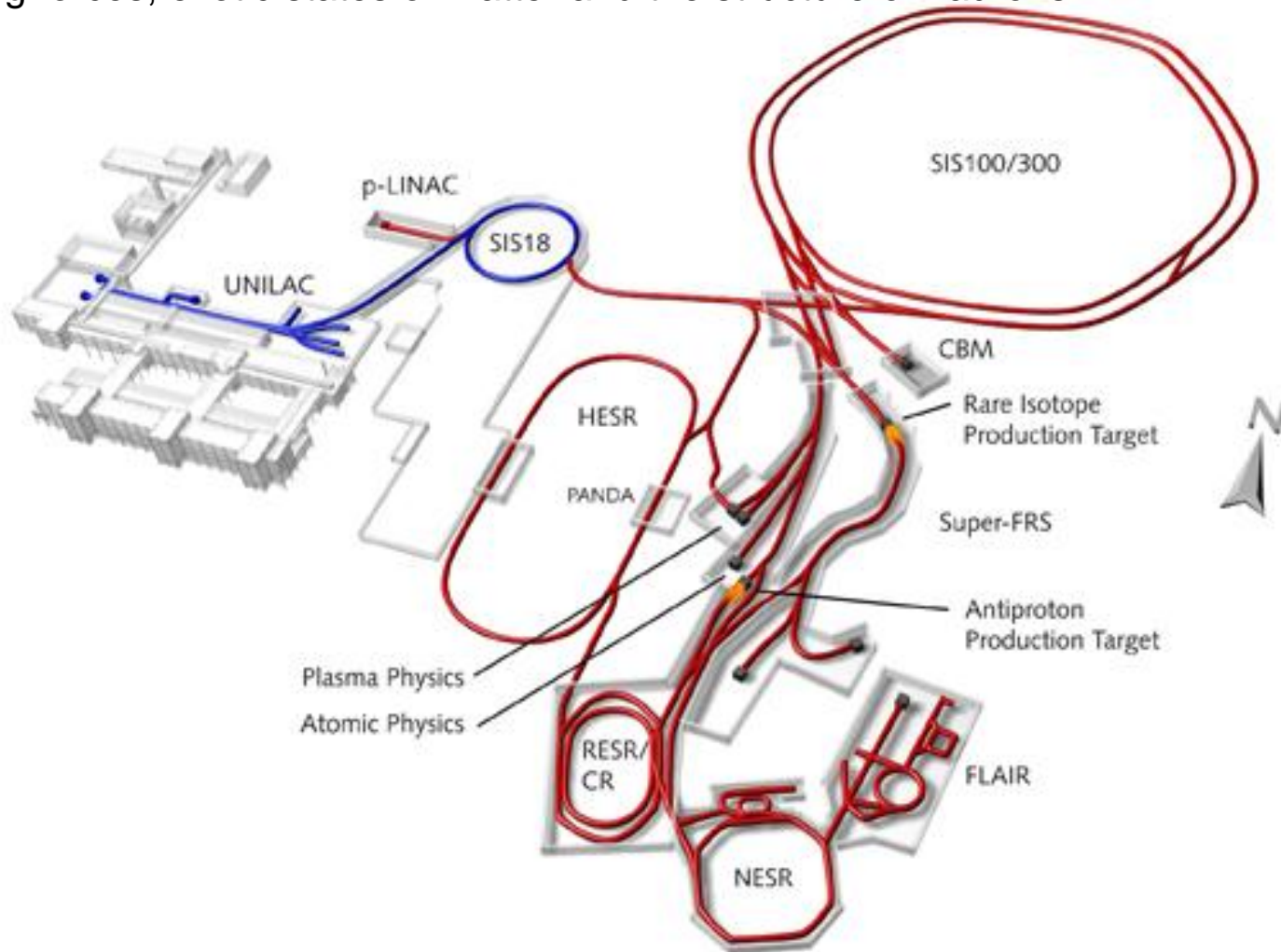

Proposed layout of HESR at FAIR

The Versatile PANDA Detector - Full View

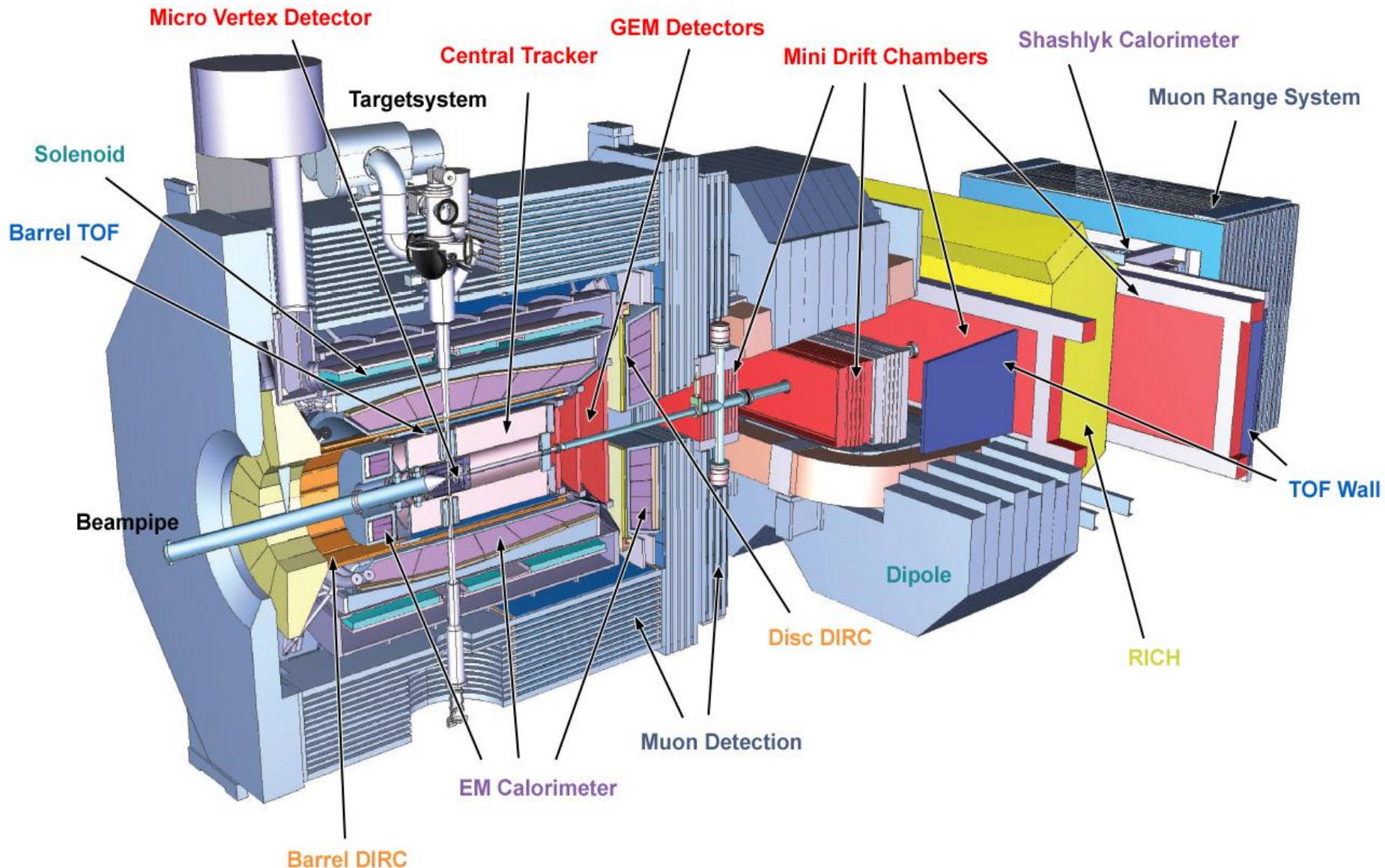

In order to yield the necessary information from the antiproton-proton collisions a **versatile PANDA detector** will be build being able to provide precise trajectory reconstruction, energy and momentum measurements and **very efficient identification of charged particles in full coverage of the solid angle and wide energy range.**



Outline

- Conventional & exotic hadrons
- Review of recent experimental data
- Analysis & results
- Summary & perspectives

PREAMBLE

- ➔ STUDY OF FLAVOUR PARTICLES (CHARMONIUM STATES, **CHARMED HYBRIDS & TETRAQUARKS**)
- ➔ ANALYSIS OF SPECTRUM IN MASS REGION ABOVE $D\bar{D}$ -THRESHOLD. A REVIEW OF THE NEW **XYZ**-CHARMONIUMLIKE MESONS AND ATTEMPTS OF THEIR POSSIBLE INTERPRETATION
- ➔ DISCUSSION OF THE RESULTS OF CALCULATION FOR THE HIGHER LYING CHARMONIUM AND EXOTICS AND THEIR COMPARISON WITH THE RECENTLY REVEALED EXPERIMENTAL DATA ABOVE $D\bar{D}$ -THRESHOLD
- ➔ APPLICATION OF THE INTEGRAL FORMALISM FOR DECAY OF HADRON RESONANCES TO CALCULATE THE WIDTHS OF CHARMONIUM AND EXOTICS

Why is charmonium (charmonium-like states) chosen!?

Charmonium possesses some well favored characteristics:

- Charmonium – is the simplest two-particle system consisting of quark & antiquark;
- Charmonium – is a compact bound system with small widths varying from several tens of keV to several tens of MeV compared to the light unflavored mesons and baryons;
- Charm quark c has a large mass (1.27 ± 0.07 GeV) compared to the masses of u , d & s (~ 0.1 GeV) quarks, that makes it plausible to attempt a description of the dynamical properties of $c\bar{c}$ – system in terms of non-relativistic potential models and phenomenological models;
- Quark motion velocities in charmonium are non-relativistic (the coupling constant, $\alpha_s \approx 0.3$ is not too large, and relativistic effects are manageable ($v^2/c^2 \approx 0.2$));
- The size of charmonium is of the order of less than 1 Fm ($R_{c\bar{c}} \sim \alpha_s \cdot m_q$) so that one of the main doctrines of QCD – asymptotic freedom is emerging;

Therefore:

- ◆ charmonium studies are promising for understanding the dynamics of quark interaction at small distances;
- ◆ charmonium spectroscopy is a good testing ground for the theories of strong interactions:
 - QCD in both perturbative and nonperturbative regimes
 - QCD inspired potential models and phenomenological models

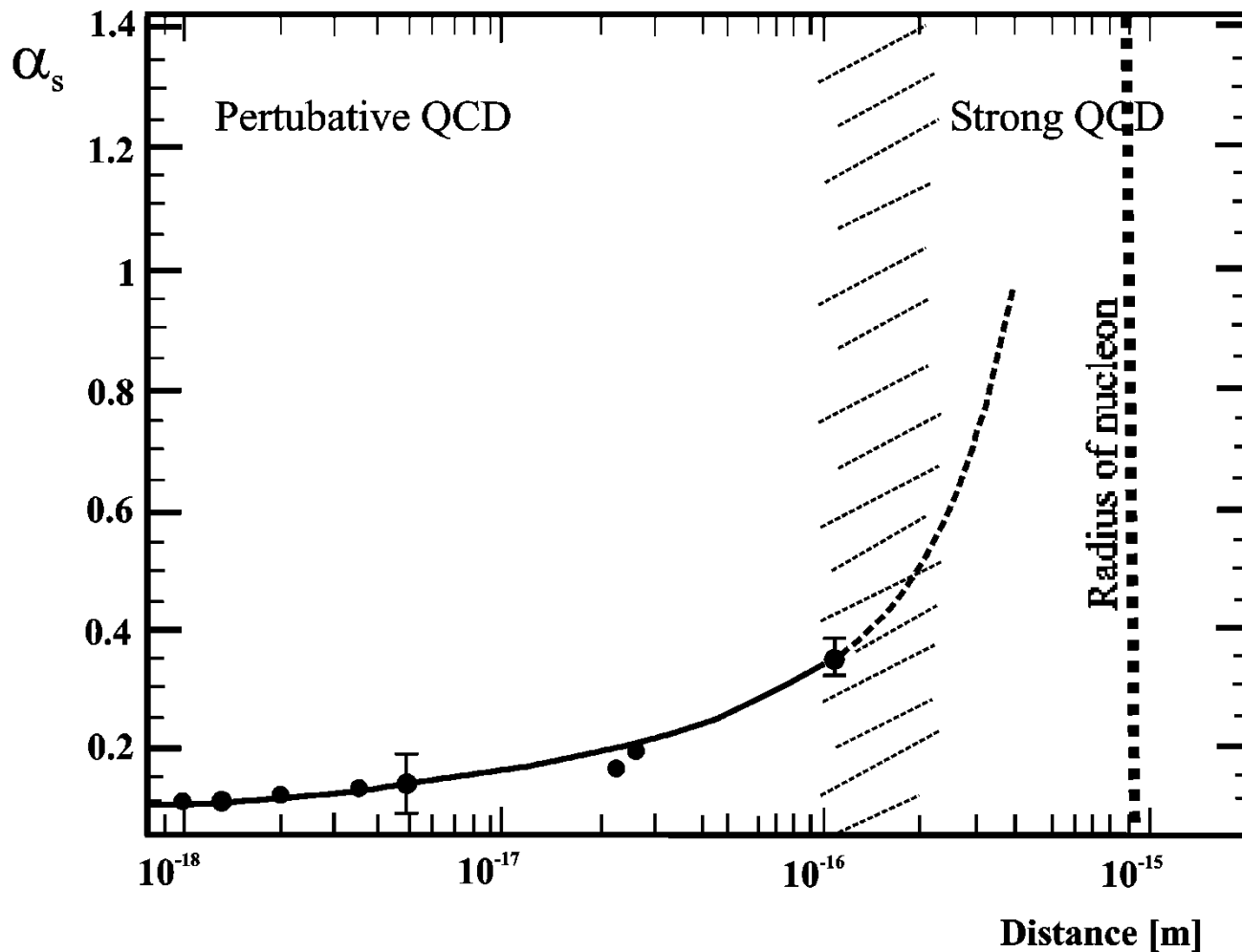

Coupling strength between two quarks as a function of their distance. For small distances ($\leq 10^{-16}$ m) the strength α_s is ≈ 0.1 , allowing a theoretical description by perturbative QCD. For distances comparable to the size of the nucleon, the strength becomes so large (strong QCD) that quarks can not be further separated: they remain confined within the nucleon and another theoretical approaches must be developed and applicable. For charmonium states $\alpha_s \approx 0.3$ and $\langle v^2/c^2 \rangle \approx 0.2$.

The quark potential models have successfully described the charmonium spectrum, which generally assumes short-range coulomb interaction and long-range linear confining interaction plus spin dependent part coming from one gluon exchange. The zero-order potential is:

$$V_0^{(c\bar{c})}(r) = -\frac{4}{3} \frac{\alpha_s}{r} + br + \frac{32\pi\alpha_s}{9m_c^2} \tilde{\delta}_\sigma(r) \vec{S}_c \cdot \vec{S}_{\bar{c}}$$

where $\tilde{\delta}_\sigma(r) = (\sigma/\sqrt{\pi})^3 e^{-\sigma^2 r^2}$ defines a gaussian-smeared hyperfine interaction.

Solution of equation with $H_0 = p^2/2m_c + V_0^{(c\bar{c})}(r)$ gives zero order charmonium wavefunctions.

**T. Barnes, S. Godfrey, E. Swanson, Phys. Rev. D 72, 054026 (2005), hep-ph/0505002 & Ding G.J. et al., arXiv: 0708.3712 [hep-ph], 2008*

The splitting between the multiplets is determined by taking the matrix element of the $V_{spin-dep}$ taken from one-gluon exchange Breit-Fermi-Hamiltonian between zero-order wave functions:

$$V_{spin-dep} = \frac{1}{m_c^2} \left[\left(\frac{2\alpha_s}{r^3} - \frac{b}{2r} \right) \vec{L} \cdot \vec{S} + \frac{4\alpha_s}{r^3} \mathbf{T} \right]$$

where α_s - coupling constant, b - string tension, σ - hyperfine interaction smear parameter.

Izmestev A. has shown **Nucl. Phys., V.52, N.6 (1990) & *Nucl. Phys., V.53, N.5 (1991)* that in the case of curved coordinate space with radius a (confinement radius) and dimension N at the dominant time component of the gluonic potential the quark-antiquark potential defines via Gauss equations. If space of physical system is compact (sphere S^3), the harmonic potential assures confinement:

$$\Delta V_N(\vec{r}) = \text{const } G_N^{-1/2}(r) \delta(\vec{r}), \quad V_N(r) = V_0 \int D(r) R^{1-N}(r) dr / r, \quad V_0 = \text{const} > 0.$$

$$R(r) = \sin(r/a), \quad D(r) = r/a, \quad V_3(r) = -V_0 \text{ctg}(r/a) + B, \quad V_0 > 0, \quad B > 0.$$

When cotangent argument in $V_3(r)$ is small: $r^2/a^2 \ll \pi^2$, $\left\{ \begin{array}{l} V(r)|_{r \rightarrow 0} \sim 1/r \\ V(r)|_{r \rightarrow \infty} \sim kr \end{array} \right.$
 we get: $\text{ctg}(r/a) \approx a/r - r/3a$, \longrightarrow

where $R(r)$, $D(r)$ and $G_N(r)$ are scaling factor, gauging and determinant of metric tensor $G_{\mu\nu}(r)$.

The $c\bar{c}$ system has been investigated in great detail first in e^+e^- -reactions, and afterwards on a restricted scale ($E_{\bar{p}} \leq 9$ GeV), but with high precision in $\bar{p}p$ -annihilation (the experiments R704 at CERN and E760/E835 at Fermilab).

The number of unsolved questions related to charmonium has remained:

- singlet 1D_2 and triplet 3D_J charmonium states are not determined yet;
- nothing is known about partial width of 1D_2 and 3D_J charmonium states.
- higher lying singlet $^1S_0, ^1P_1$ and triplet $^3S_1, ^3P_J$ – charmonium states are poorly investigated;
- only few partial widths of 3P_J -states are known (some of the measured decay widths don't fit theoretical schemes and additional experimental check or reconsideration of the corresponding theoretical models is needed, more data on different decay modes are desirable to clarify the situation);

AS RESULT:

- little is known on charmonium states above the the $D\bar{D}$ – threshold (S, P, D, \dots);
- many recently discovered states above $D\bar{D}$ - threshold (XYZ -states) expect their verification and explanation (their interpretation now is far from being obvious).

IN GENERAL ONE CAN IDENTIFY THREE MAIN CLASSES OF CHARMONIUM DECAYS:

- ! decays into particle-antiparticle or $D\bar{D}$ -pair: $\bar{p}p \rightarrow (\Psi, \eta_c, \chi_{cJ}, \dots) \rightarrow \Sigma^0 \bar{\Sigma}^0, \Lambda \bar{\Lambda}, \Sigma^0 \bar{\Sigma}^0 \pi, \Lambda \bar{\Lambda} \pi$;
- decays into light hadrons: $\bar{p}p \rightarrow (\Psi, \eta_c, \dots) \rightarrow \rho \pi$; $\bar{p}p \rightarrow \Psi \rightarrow \pi^+ \pi^-$, $\bar{p}p \rightarrow \Psi \rightarrow \omega \pi^0, \eta \pi^0, \dots$;
- decays with J/Ψ , Ψ' and h_c in the final state: $\bar{p}p \rightarrow J/\Psi + X \Rightarrow \bar{p}p \rightarrow J/\Psi \pi^+ \pi^-$, $\bar{p}p \rightarrow J/\Psi \pi^0 \pi^0$;
 $\bar{p}p \rightarrow \Psi' + X \Rightarrow \bar{p}p \rightarrow \Psi' \pi^+ \pi^-$, $\bar{p}p \rightarrow \Psi' \pi^0 \pi^0$; $\bar{p}p \rightarrow h_c + X \Rightarrow \bar{p}p \rightarrow h_c \pi^+ \pi^-$, $\bar{p}p \rightarrow h_c \pi^0 \pi^0$.

$c\bar{c}$ meson spectrum

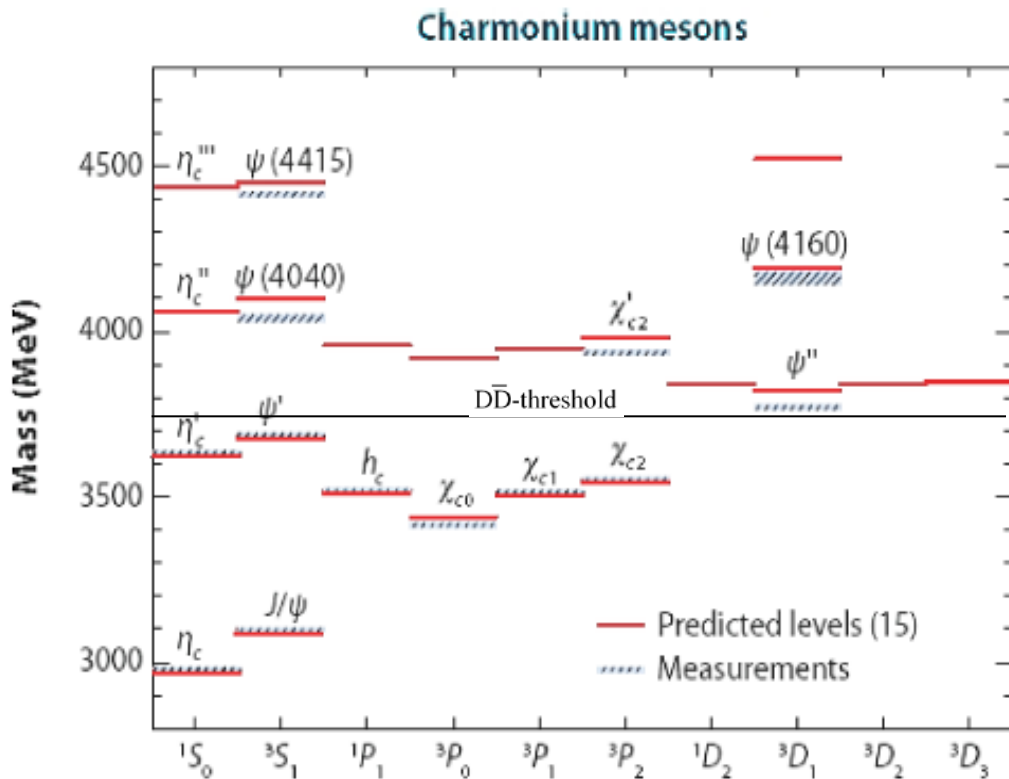

- mass spectrum predicted by potential models and lattice calculations
- good agreement with data below $D\bar{D}$ threshold
- missing states above threshold
- defined basis to study meson structure

The figure was taken from S. Godfrey & S. Olsen, *Annu. Rev. Nucl. Part. Sci.*, **58**, 51 (2008).

A more fundamental approach,
Lattice QCD:

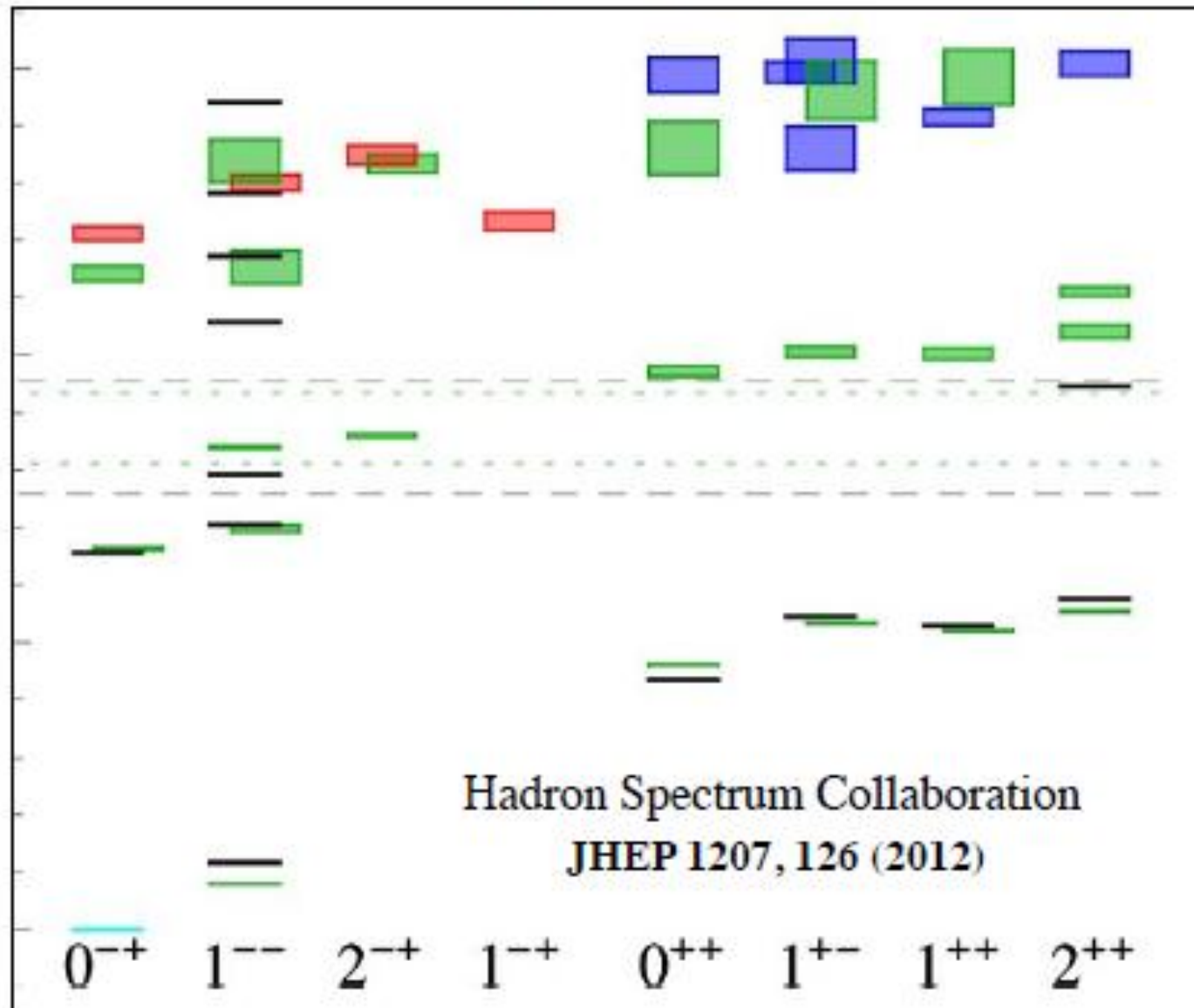

charmonium spectrum

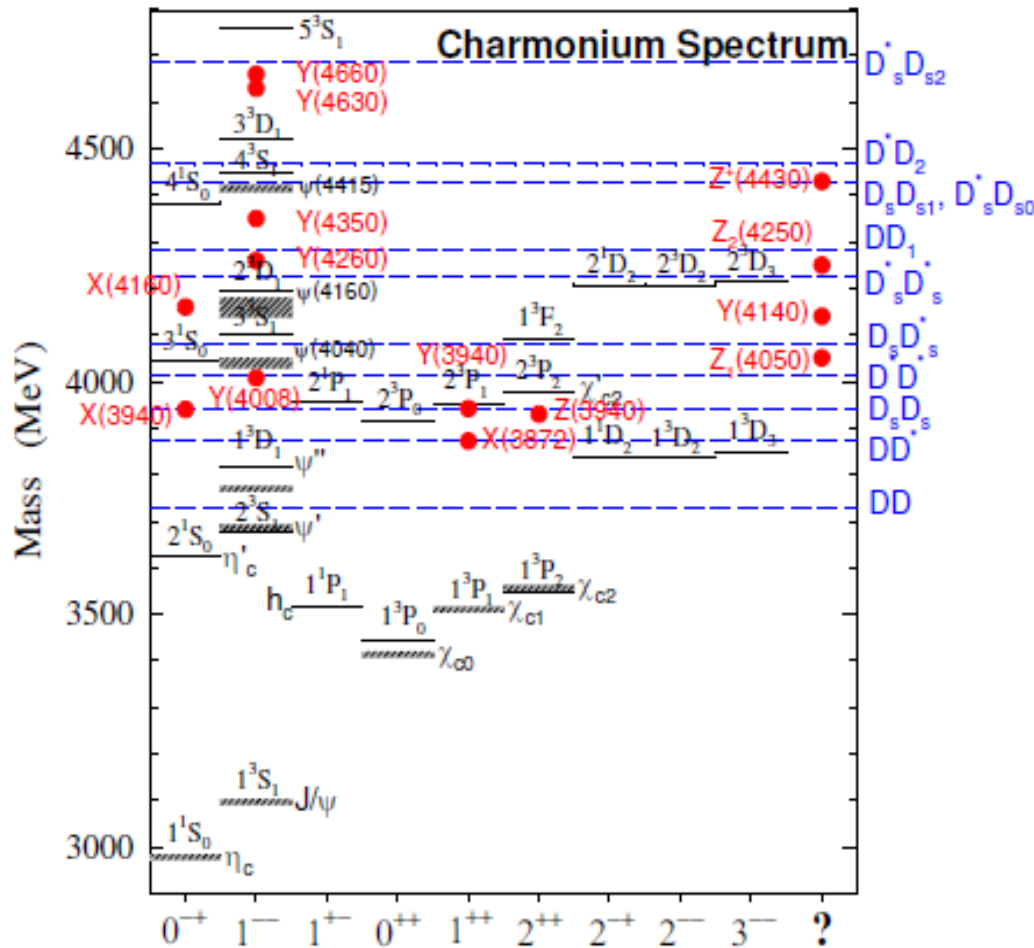

- all $c\bar{c}$ states below open charm threshold have been identified
- good agreement between data and theory
- something new above open charm threshold
- the theoretical picture for exotic states is far from being clear at present

Exotica Experimental Summary

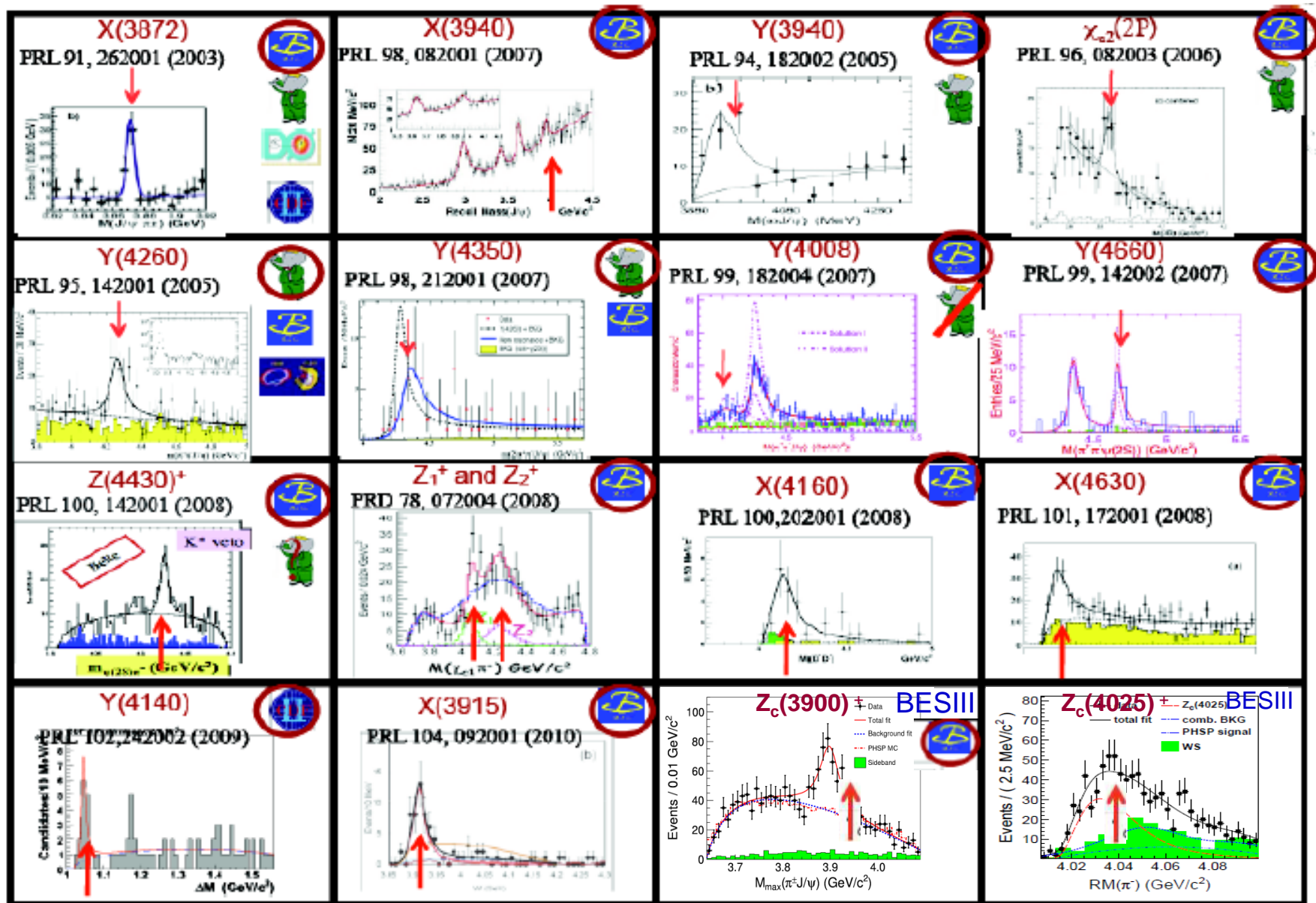

Many (> 20) new states: above $D\bar{D}$ - threshold for the recent years were revealed in experiment. Most of these heavy states are not explained by theory and wait for their verification and explanation.

Experiments

CLEOC

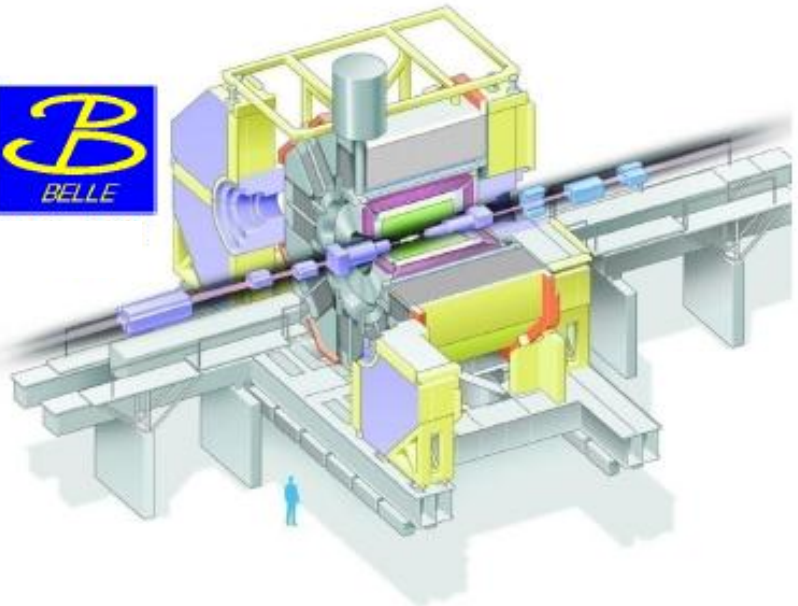
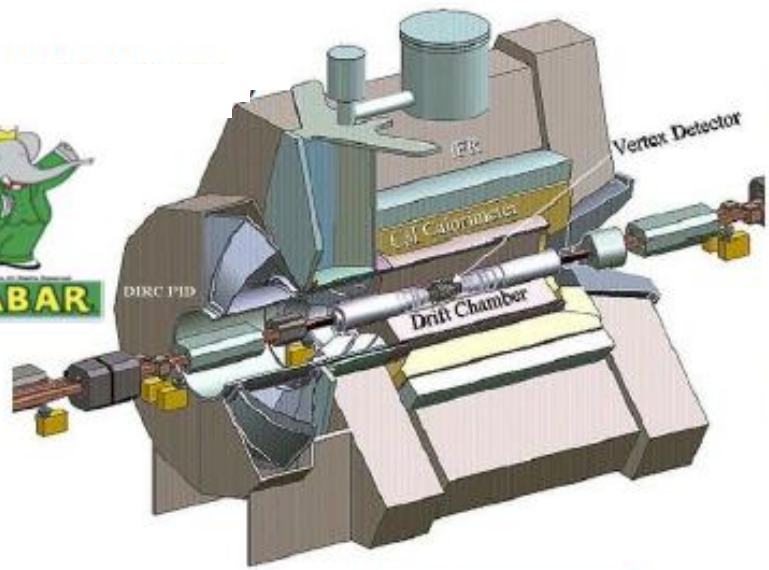
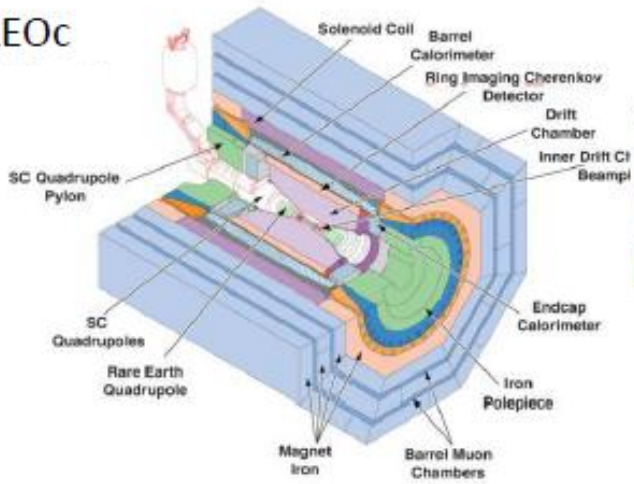

BESIII

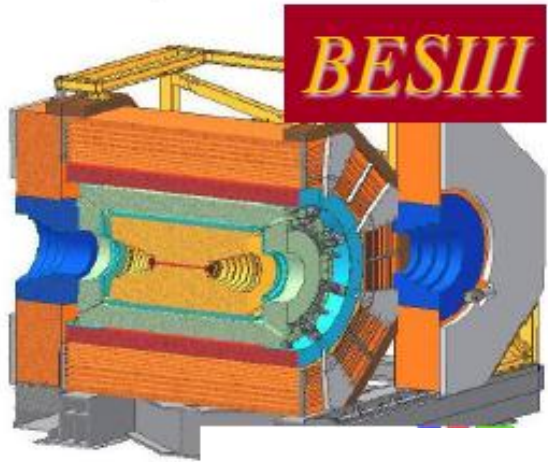

very schematically, clusters of new states

- $X(3872)$, the first surprise
- the 3940 family ←
- the Y family (1^{--} states):
 - $Y(4260) \rightarrow J/\psi\pi\pi, K^+K^-$
 - $Y(4350) \rightarrow \psi(2S)\pi^+\pi^-$
 - $Y(4630) \rightarrow \Lambda_c\bar{\Lambda}_c$
 - $Y(4660) \rightarrow \psi(2S)\pi^+\pi^-$

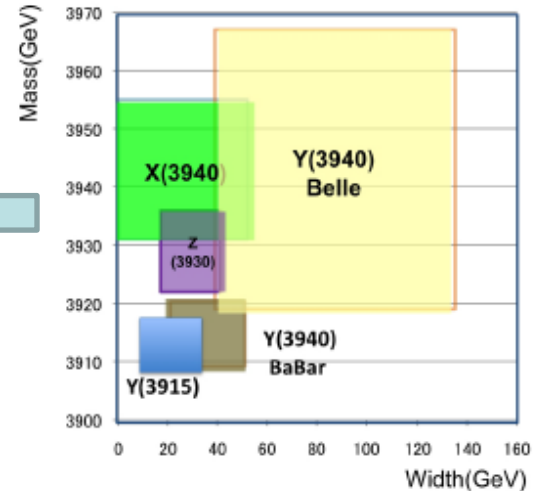

- charged states

- $Z(4430) \rightarrow \psi(2S)\pi^\pm$
- $Z_1(4050), Z_2(4250) \rightarrow \chi_{c1}(2S)\pi^\pm$ ←

BES III

$Z_c(3900)^\pm \rightarrow J/\psi\pi^\pm$

$Z_c(3885)^\pm \rightarrow D\bar{D}^*$

$Z_c(4025)^\pm \rightarrow D^*\bar{D}^*$

$Z_c(4020)^\pm \rightarrow h_c\pi^\pm$

- $C = +$ states

- $X(4160) \rightarrow D^*\bar{D}^*$
- $Y(4140) \rightarrow J/\psi\phi$
- $X(4350)$

**WHAT ARE THESE STATES?
CHARMONIUM OR EXOTICS?**

CHARMONIUM PRODUCTION MECHANISMS

$B \rightarrow c\bar{c} K^{(*)}$ decays

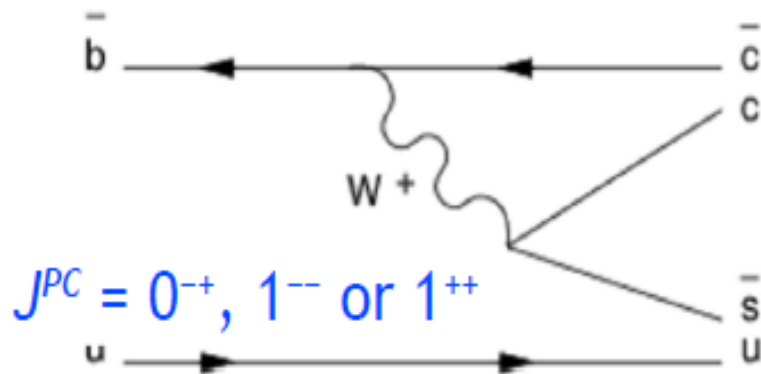

Initial State Radiation (ISR)

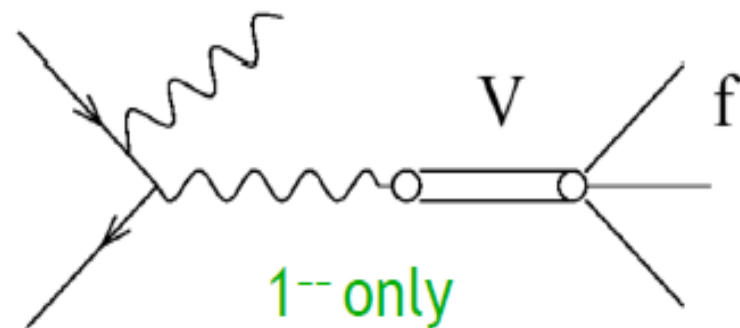

Two-photon fusion

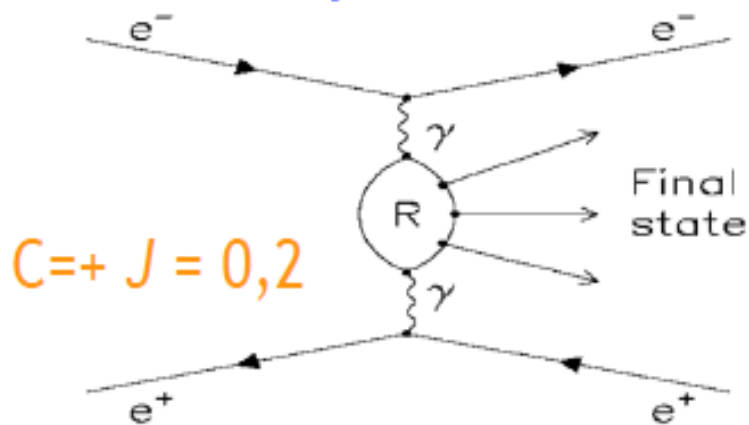

Double charmonium

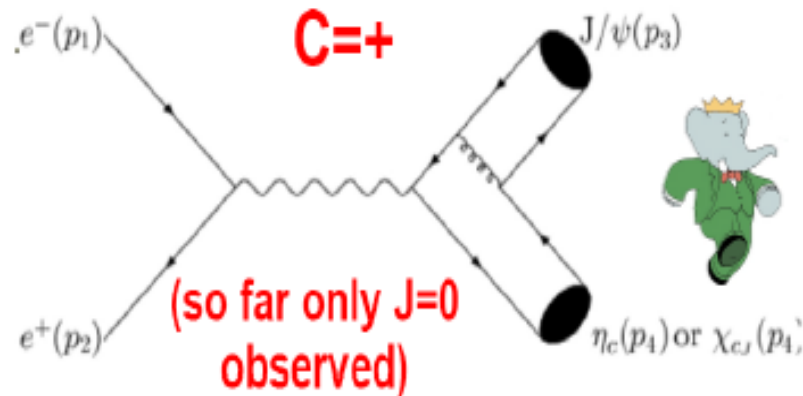

Besides mesons and baryons, other “exotic” combinations of quarks and gluons could exist (i.e. are not forbidden by QCD). This include for example

New states may be exotics **somehow expected** by QCD, but **never observed** so far:

Hybrids:

- Excited gluonic degree of freedom.
- Lowest mass states $\sim 4.2 \text{ GeV}/c^2$.

Hadrocharmonium:

- $c\bar{c}$ state “coated” by light hadrons.
- Compatible with small width above threshold and non-zero charge.

Multiquark states:

- Tetraquarks & $D^{(*)}\bar{D}^{(*)}$ molecules.
- Compatible with small width above threshold and non-zero charge.
- Few molecular, lot of tetraquark states expected.

Threshold effects (npQCD at work):

- Virtual states/cusps at threshold openings.
- Charmonium with mass shifted by nearby $D^{(*)}\bar{D}^{(*)}$ thresholds.

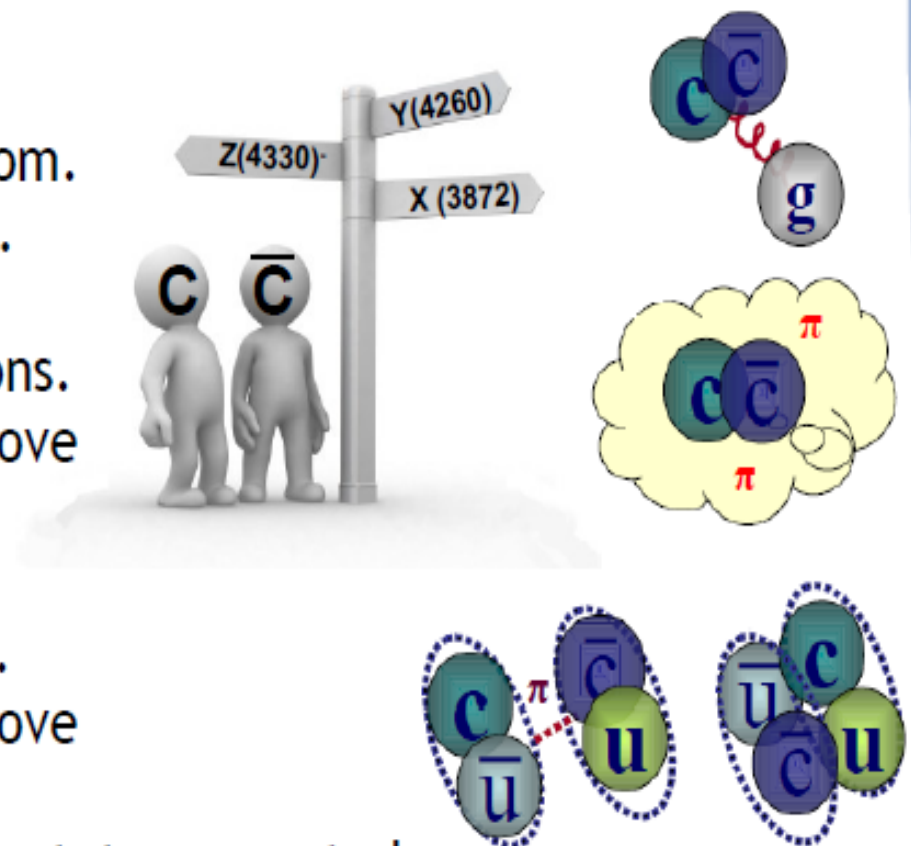

Two different kinds of experiments are foreseen at FAIR :

- production experiment – $\bar{p}p \rightarrow X + M$, where $M = \pi, \eta, \omega, \dots$ (conventional states plus states with exotic quantum numbers)
- formation experiment (annihilation process) – $\bar{p}p \rightarrow X \rightarrow M_1 M_2$ (conventional states plus states with non-exotic quantum numbers)

The low laying charmonium hybrid states:

	Gluon	
$(q\bar{q})_8$	1^- (TM)	1^+ (TE)
$^1S_0, 0^{-+}$	1^{++}	1^{--}
$^3S_1, 1^{--}$	$0^{+-} \leftarrow$ exotic	0^{-+}
	1^{+-}	$1^{-+} \leftarrow$ exotic
	$2^{+-} \leftarrow$ exotic	2^{-+}

Charmonium hybrids predominantly decay via electromagnetic and hadronic transitions and into the open charm final states:

- $\bar{c}c g \rightarrow (\Psi, \chi_{cJ}) +$ light mesons ($\eta, \eta', \omega, \phi$) - these modes supply small widths and significant branch fractions;
- $\bar{c}c g \rightarrow D\bar{D}_J^*$. In this case *S-wave* ($L = 0$) + *P-wave* ($L = 1$) final states should dominate over decays to $D\bar{D}$ (are forbidden $\rightarrow CP$ violation) and partial width to should be very small.

The most interesting and promising decay channels of charmed hybrids have been, in particular, analyzed:

- $\bar{p}p \rightarrow \tilde{\eta}_{c0,1,2} (0^{+}, 1^{+}, 2^{+}) \eta \rightarrow \chi_{c0,1,2} (\eta, \pi\pi, \dots);$
- $\bar{p}p \rightarrow \tilde{h}_{c0,1,2} (0^{+-}, 1^{+-}, 2^{+-}) \eta \rightarrow \chi_{c0,1,2} (\eta, \pi\pi, \dots);$
- $\bar{p}p \rightarrow \tilde{\Psi} (0^{-}, 1^{-}, 2^{-}) \rightarrow J/\Psi (\eta, \omega, \pi\pi, \dots);$
- $\bar{p}p \rightarrow \tilde{\eta}_{c0,1,2}, \tilde{h}_{c0,1,2}, \tilde{\chi}_{c1} (0^{+}, 1^{+}, 2^{+}, 0^{+-}, 1^{+-}, 2^{+-}, 1^{++}) \eta \rightarrow D\bar{D}_J^* \eta .$

$J^{PC} = 0^{-} \rightarrow$ exotic!

According to the constituent quark model tetraquark states are classified in terms of the diquark and antidiquark spin S_{cq} , $S_{\bar{c}\bar{q}}$, total spin of diquark-antidiquark system S , total angular momentum J , spatial parity P and charge conjugation C . The following states with definite quantum numbers J^{PC} are expected to exist:

! - two states with $J=0$ and positive P -parity $J^{PC} = 0^{++}$ i.e., $|0_{cq}, 0_{\bar{c}\bar{q}}; S=0, J=0\rangle$ and $|1_{cq}, 1_{\bar{c}\bar{q}}; S=0, J=0\rangle$;

! - three states with $J=0$ and negative P -parity i.e., $|A\rangle = |1_{cq}, 0_{\bar{c}\bar{q}}; S=1, J=0\rangle$; $|B\rangle = |0_{cq}, 1_{\bar{c}\bar{q}}; S=1, J=0\rangle$; $|C\rangle = |1_{cq}, 1_{\bar{c}\bar{q}}; S=1, J=0\rangle$. State $|C\rangle$ is even under charge conjugation. Taking symmetric and antisymmetric combinations of states $|A\rangle$ and $|B\rangle$ we obtain a C -odd and C -even state respectively; therefore we have one state with $J^{PC} = 0^{-}$ i.e., $|0^{-}\rangle = \frac{1}{\sqrt{2}}(|A\rangle + |B\rangle)$ and two states

with $J^{PC} = 0^{+}$ i.e., $|0^{+}\rangle_1 = \frac{1}{\sqrt{2}}(|A\rangle - |B\rangle)$; $|0^{+}\rangle_2 = |C\rangle$.

! - three states with $J=1$ and positive P -parity i.e., $|D\rangle = |1_{cq}, 0_{\bar{c}\bar{q}}; S=1, J=1\rangle$; $|E\rangle = |0_{cq}, 1_{\bar{c}\bar{q}}; S=1, J=1\rangle$; $|F\rangle = |1_{cq}, 1_{\bar{c}\bar{q}}; S=1, J=1\rangle$. State $|F\rangle$ is odd under charge conjugation. Operating $|D\rangle$ and $|E\rangle$ in the same way as for states $|A\rangle$ and $|B\rangle$ we obtain one state with $J^{PC} = 1^{++}$ state i.e., $|1^{++}\rangle = \frac{1}{\sqrt{2}}(|D\rangle + |E\rangle)$ and two states with $J^{PC} = 1^{+}$ i.e., $|1^{+}\rangle_1 = \frac{1}{\sqrt{2}}(|D\rangle - |E\rangle)$; $|1^{+}\rangle_2 = |F\rangle$.

! - one state with $J=2$ and positive P -parity $J^{PC} = 2^{++}$ i.e., $|1_{cq}, 1_{\bar{c}\bar{q}}; S=1, J=2\rangle$.

! • $\bar{p}p \rightarrow X \rightarrow J/\Psi \rho \rightarrow J/\Psi \pi\pi$, $\bar{p}p \rightarrow X \rightarrow J/\Psi \omega \rightarrow J/\Psi \pi\pi\pi$, $\bar{p}p \rightarrow X \rightarrow \chi_{cJ} \pi$ (decays into J/Ψ , Ψ' , χ_{cJ} and light mesons);

! • $\bar{p}p \rightarrow X \rightarrow D\bar{D}^* \rightarrow D\bar{D} \gamma$, $\bar{p}p \rightarrow X \rightarrow D\bar{D}^* \rightarrow D\bar{D} \eta$ (decays into $D\bar{D}^*$ -pair).

The first charged state: Z(4430)!



$$B^\pm \rightarrow Z^\pm K_S \text{ or } B^0 \rightarrow Z^i K^\pm$$

$$Z^\pm \rightarrow \psi(2S)\pi^\pm$$

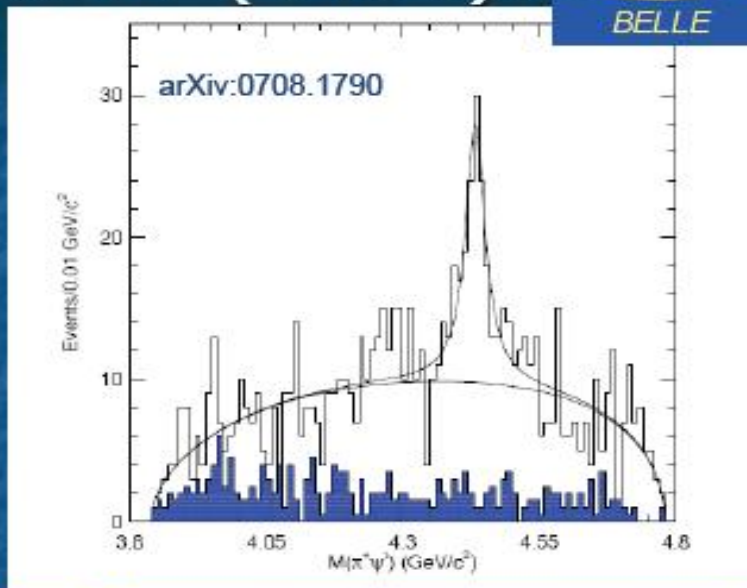

Total significance: 7.3s

$$M = (4433 \pm 4) \text{ MeV}$$

$$\Gamma = (44^{+17}_{-13}) \text{ MeV}$$

Too narrow to be a reflection

$$BF(B \rightarrow KZ) \times BF(Z \rightarrow \psi(2S)\pi) = (4.1 \pm 1.0 \pm 1.3) 10^{-5}$$

Subset	Signal events	Mass (GeV)	Width (GeV)	signif. (σ)	constr. yield ($\Gamma = 0.044\text{GeV}$)
$\psi' \rightarrow \pi^+\pi^- J/\psi$	52.9 ± 15.1	4.435 ± 0.004	$0.026^{+0.013}_{-0.008}$	5.5	67.3 ± 14.9
$\psi' \rightarrow \ell^+\ell^-$	104.8 ± 34.5	4.435 ± 0.010	$0.097^{+0.041}_{-0.031}$	5.6	60.1 ± 13.8
$J/\psi(\psi') \rightarrow e^+e^-$	45.4 ± 16.6	4.430 ± 0.010	$0.052^{+0.026}_{-0.020}$	4.1	40.9 ± 11.9
$J/\psi(\psi') \rightarrow \mu^+\mu^-$	79.4 ± 24.6	4.434 ± 0.004	$0.039^{+0.022}_{-0.013}$	6.1	84.8 ± 17.0
$K^\pm \pi^\mp \psi'$	106.5 ± 26.6	4.434 ± 0.005	$0.046^{+0.017}_{-0.013}$	6.6	104.7 ± 18.6
$K_S \pi^\mp \psi'$	21.0 ± 8.3	4.430 ± 0.009	0.046-fixed	3.0	20.6 ± 8.2
vary K^* veto	238.1 ± 64.2	4.436 ± 0.005	$0.068^{+0.031}_{-0.019}$	7.9	178.4 ± 26.4

Xcheck: separate in subsamples

BF and mass consistent between B^\pm and B^0 within large errors [in B^\pm decays $M = (4430 \pm 9) \text{ MeV} \cdot BF_+/BF_- = 1.0 \pm 0.4$]

R.Faccini,
LeptonPhoton
Conference 2007

Prior search with no evidence:
 $B \rightarrow X^+ K$ with $X^+ \rightarrow J/\psi \pi \pi^0$



PRD 71, 031501 (2005)



Belle observed Two $Z^\pm \rightarrow \chi_{c1} \pi^\pm$

- Dalitz-plot analysis of $\underline{B}^0 \rightarrow \chi_{c1} \pi^+ K^-$ $\chi_{c1} \rightarrow J/\psi \gamma$ with 657M $\underline{B}\underline{B}$
- Dalitz plot models: known $K^* \rightarrow K\pi$ only

K^* 's + one $Z \rightarrow \chi_{c1} \pi^\pm$

K^* 's + two Z^\pm states \Rightarrow favored by data

PRD 78, 072004 (2008)

Significance: 5.7σ

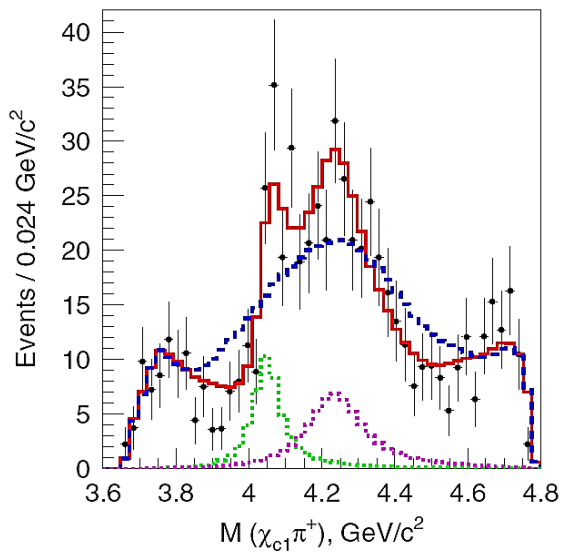
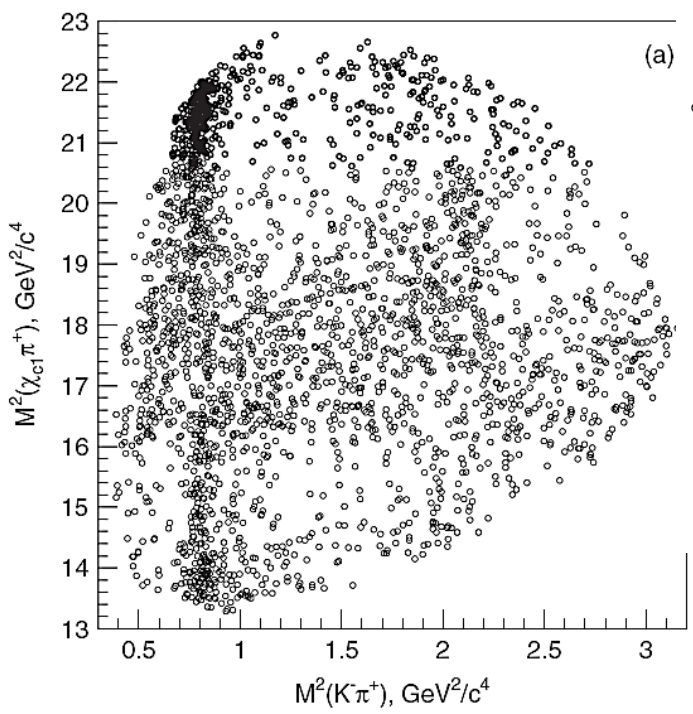

- fit for model with K^* 's
- fit for double Z model
- Z_1 contribution
- Z_2 contribution

$M(\chi_{c1}\pi^+)$
 for $1 < M^2(K\pi^+) < 1.75 \text{GeV}^2$

$$M_{Z_1} = 4051 \pm 14^{+20}_{-41} \text{ MeV}$$

$$\Gamma_{Z_1} = 82^{+21+47}_{-17-22} \text{ MeV}$$

$$M_{Z_2} = 4248^{+44+180}_{-29-35} \text{ MeV}$$

$$\Gamma_{Z_2} = 177^{+54+316}_{-39-61} \text{ MeV}$$

$Z^\pm(4430)$ in $\bar{B}^0 \rightarrow K^-(\pi^+\psi')$

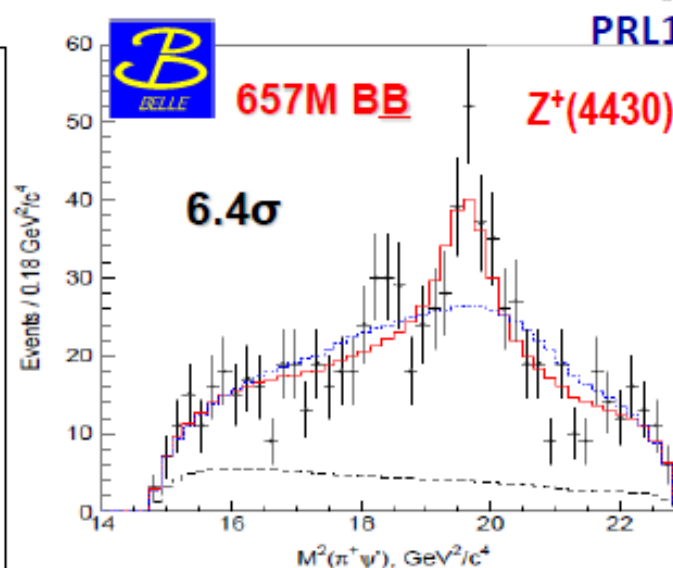
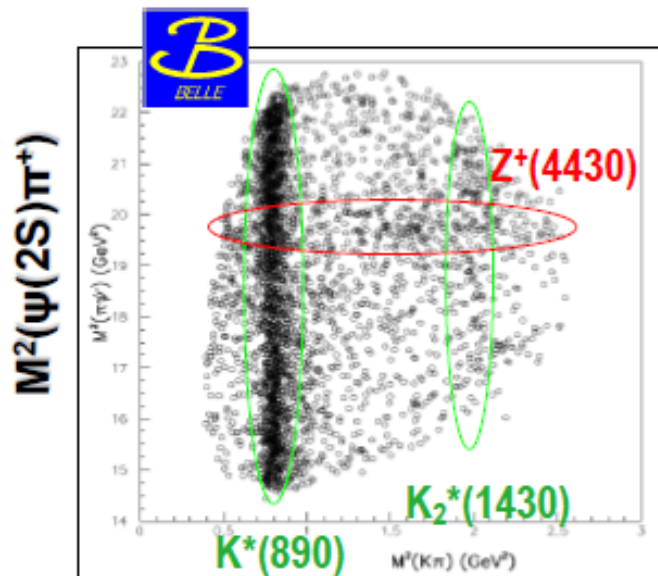

PRL100, 142001 (2008)

$J^P = 1^+$ favored
over 0^-

arXiv: 1306.4894

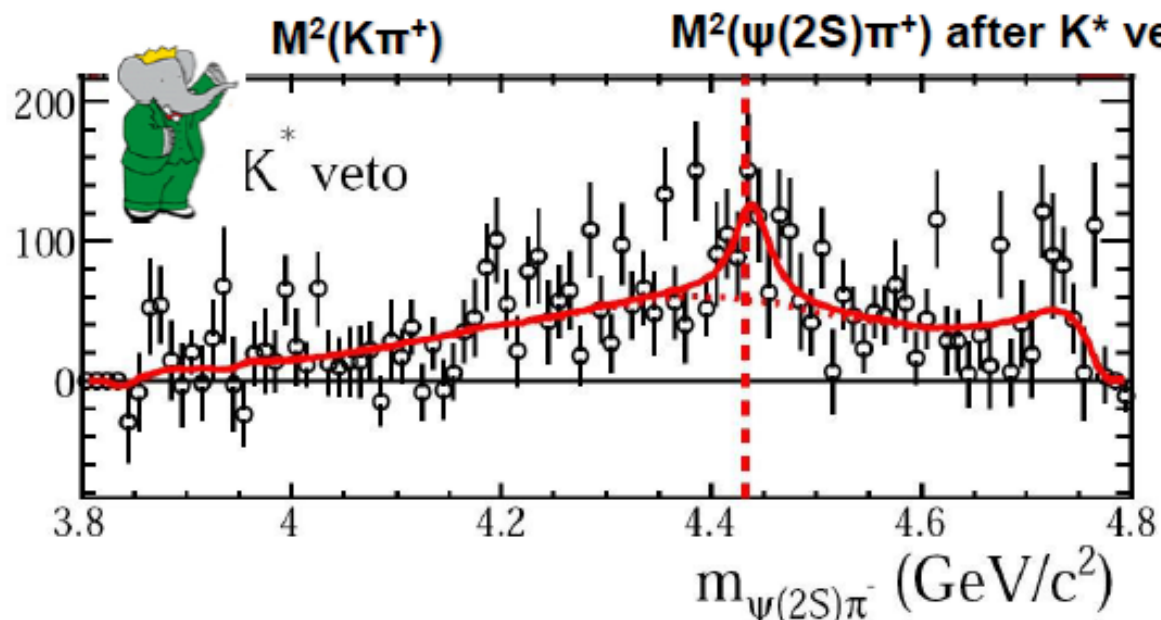

Babar didn't see a
significant $Z^\pm(4430)$.

PRD79, 112001 (2009)

Z_1^\pm and Z_2^\pm in $\bar{B}^0 \rightarrow K(\pi^\pm \chi_{c1})$

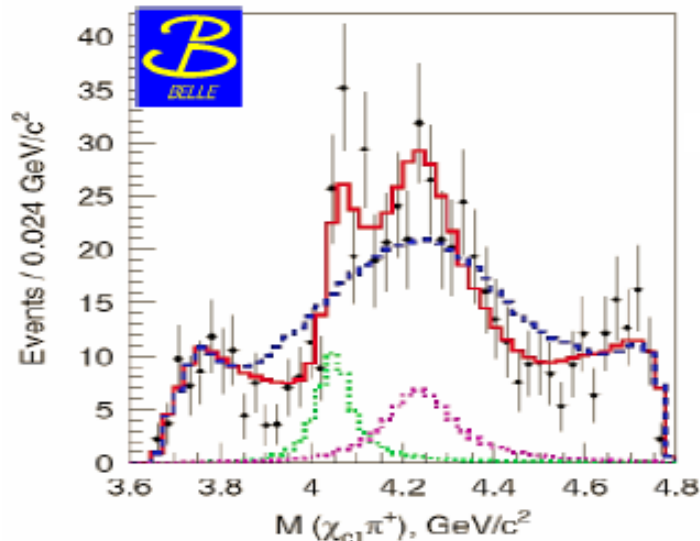

PRD 78, 072004 (2008)

- — fit for model with K^* 's
- fit for double Z model
- — Z_1 contribution
- — Z_2 contribution

$$M_1 = (4051 \pm 14_{-41}^{+20}) \text{ MeV}/c^2,$$

$$\Gamma_1 = (82_{-17}^{+21} {}_{-22}^{+47}) \text{ MeV},$$

$$M_2 = (4248_{-29}^{+44} {}_{-35}^{+180}) \text{ MeV}/c^2,$$

$$\Gamma_2 = (177_{-39}^{+54} {}_{-61}^{+316}) \text{ MeV},$$

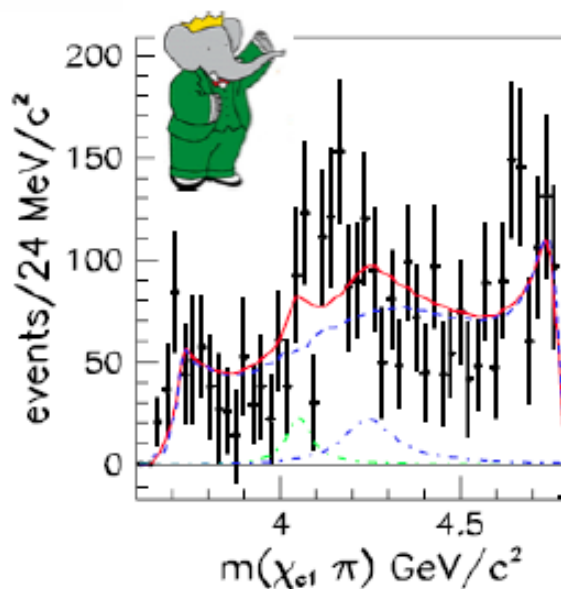
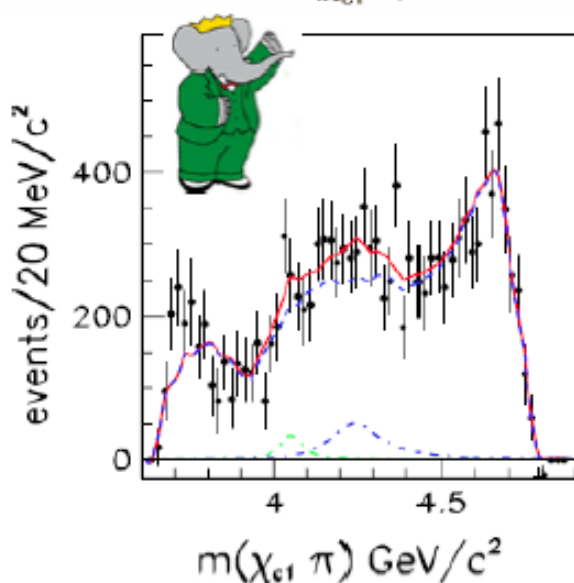

Babar didn't see significant $Z_{1,2}^\pm$.

Significance $< 2\sigma$

PRD 85, 052003 (2012)

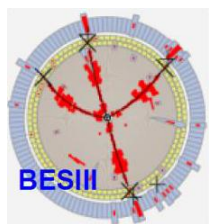

The $Z_c(3900)$ signal

BESIII: arXiv:1303.5949

BESIII: PRL110, 252001 (2013)

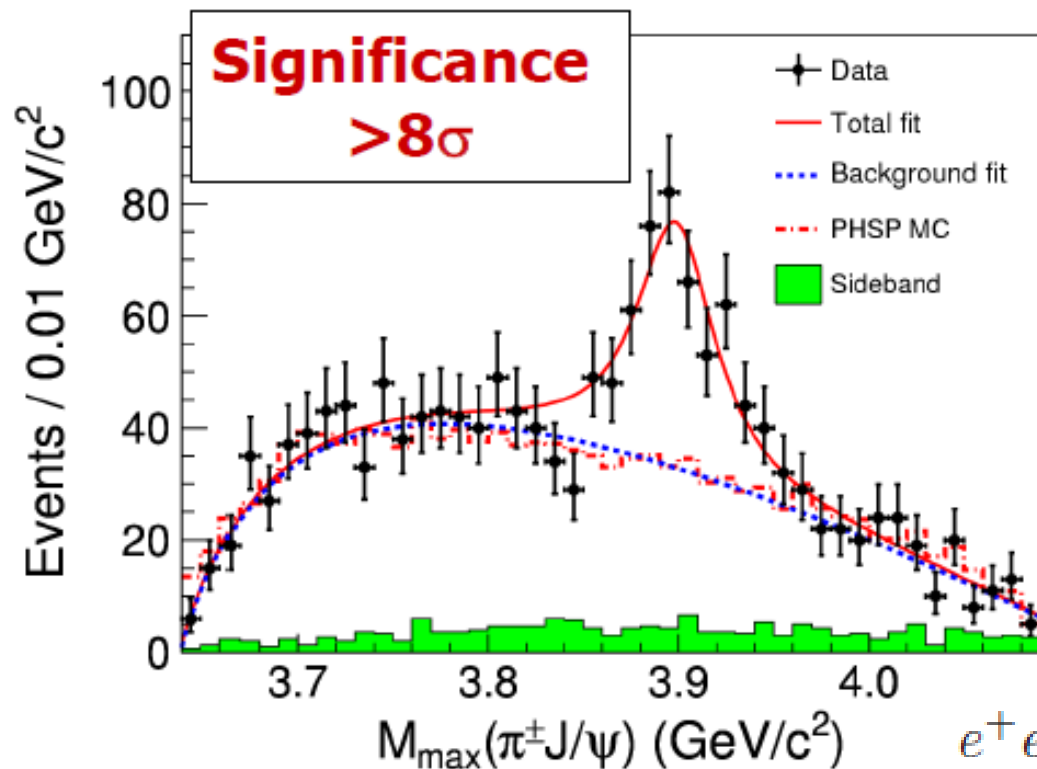

- Couples to cc
- Has electric charge
- At least 4-quarks
- What is its nature?

$$e^+e^- \rightarrow \pi^+\pi^- J/\psi$$

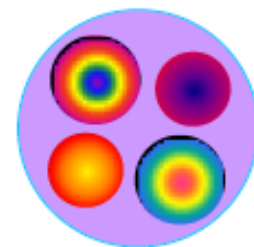

- S-wave Breit-Wigner with efficiency correction
- Mass = $(3899.0 \pm 3.6 \pm 4.9)$ MeV
- Width = $(46 \pm 10 \pm 20)$ MeV
- Fraction = $(21.5 \pm 3.3 \pm 7.5)\%$

BELLE : $e^+e^- \rightarrow \pi^+\pi^-J/\psi$ from ISR
Belle: PRL 110, 252002(2013)

CLEOc data at 4.17 GeV
arXiv: 1304.3036

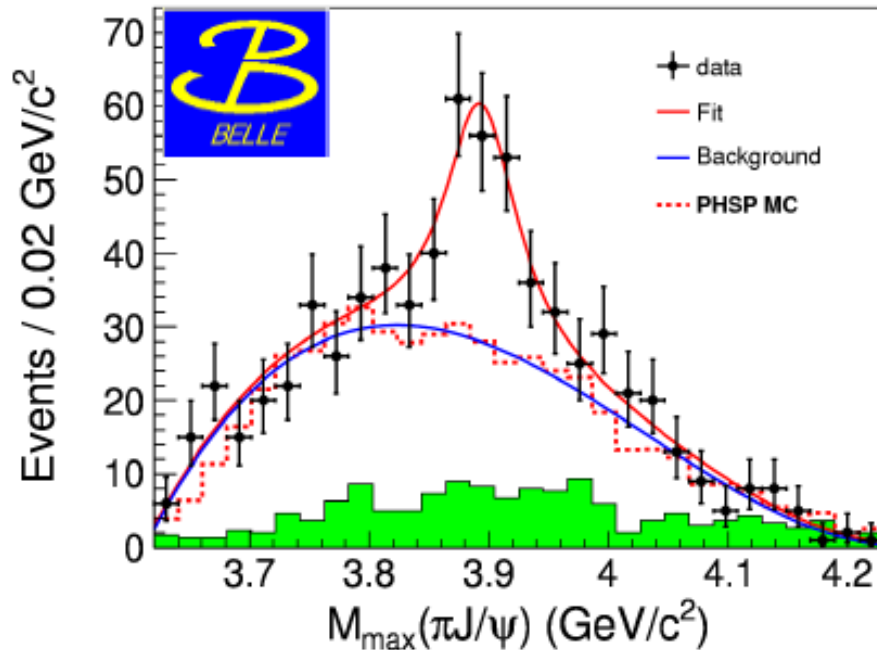

- $M = 3894.5 \pm 6.6 \pm 4.5$ MeV
- $\Gamma = 63 \pm 24 \pm 26$ MeV
- 159 ± 49 events
- $>5.2\sigma$

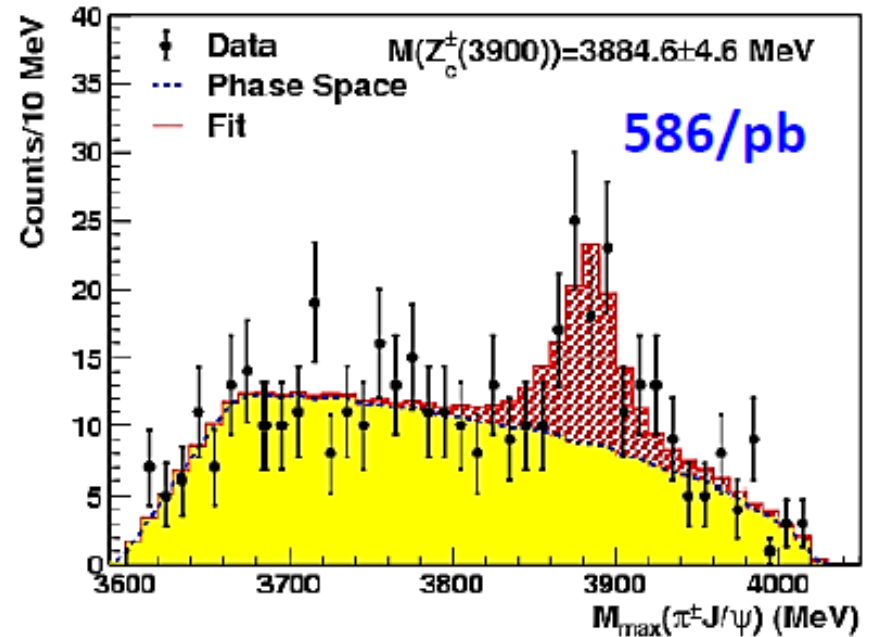

- $M = 3885 \pm 5 \pm 1$ MeV
- $\Gamma = 34 \pm 12 \pm 4$ MeV
- 81 ± 20 events
- 6.1σ

$e^+e^- \rightarrow \pi Z_c(4025) \rightarrow \pi^- (D^* \bar{D}^*)^+ + c.c.$

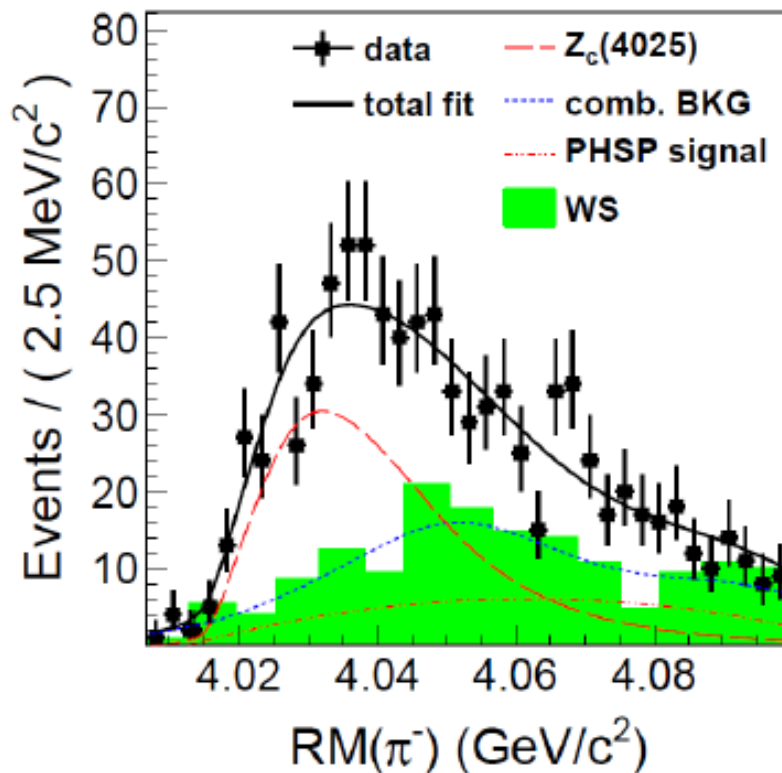
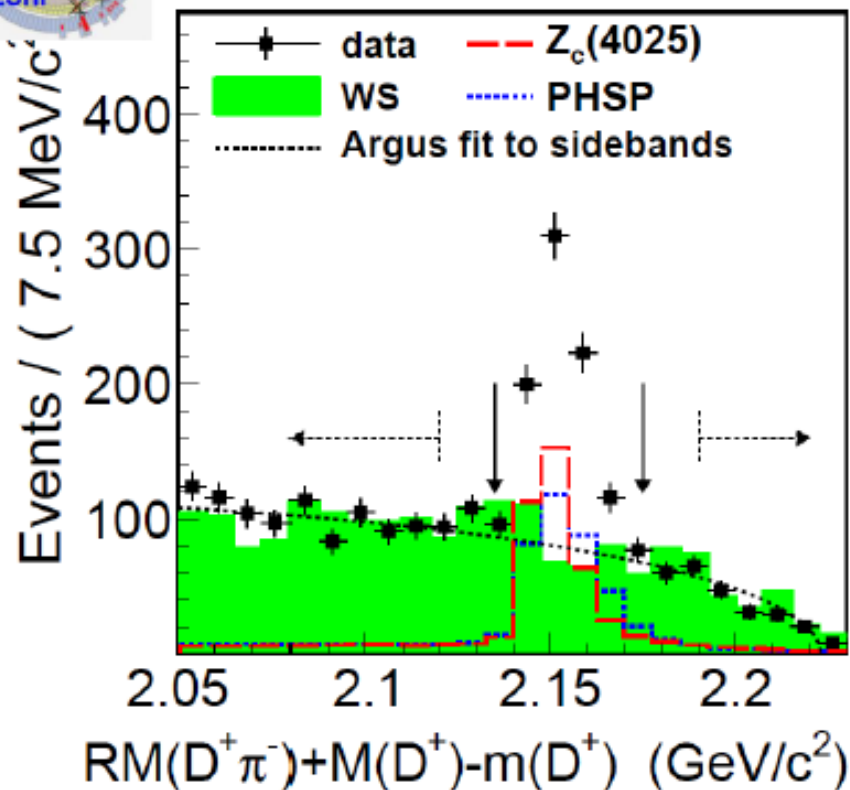
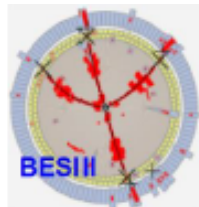

Fit to π^\pm recoil mass yields 401 ± 47 $Z_c(4025)$ events. **$>10\sigma$**

$M(Z_c(4025)) = 4026.3 \pm 2.6 \pm 3.7$ MeV; $\Gamma(Z_c(4025)) = 24.8 \pm 5.6 \pm 7.7$ MeV

$$R = \frac{\sigma(e^+e^- \rightarrow \pi^\pm Z_c(4025) \rightarrow \pi^\pm (D^* \bar{D}^*)^\mp)}{\sigma(e^+e^- \rightarrow \pi^\pm (D^* \bar{D}^*)^\mp)} = (65 \pm 9 \pm 6)\%$$

$$\sigma(e^+e^- \rightarrow \pi^\pm (D^* \bar{D}^*)^\mp) = (137 \pm 9 \pm 15) \text{ pb}$$

BESIII: 1308.2760

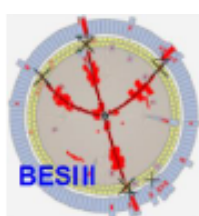

$e^+e^- \rightarrow \pi Z_c(4020) \rightarrow \pi^+\pi^-h_c(1P)$

$E_{cm}=4.26$ GeV

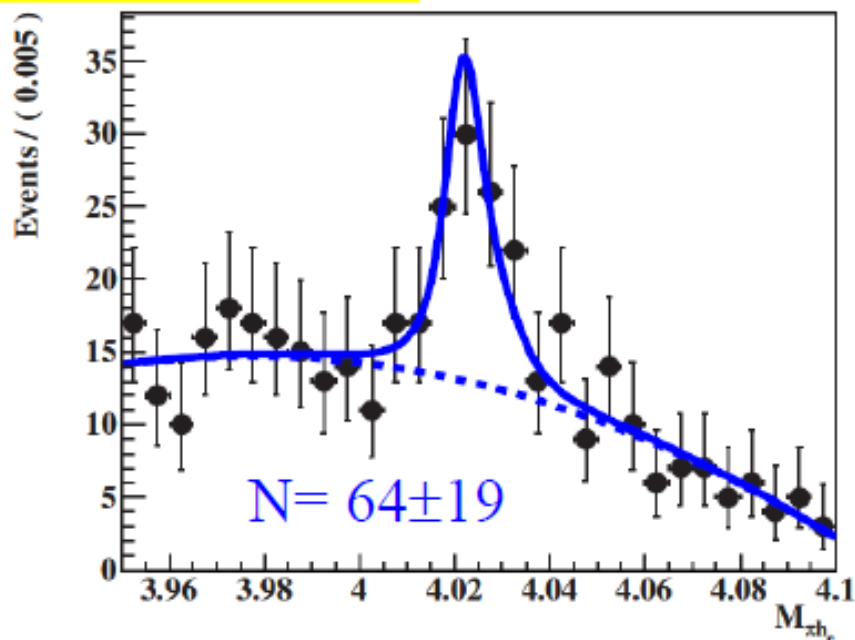

$E_{cm}=4.36$ GeV

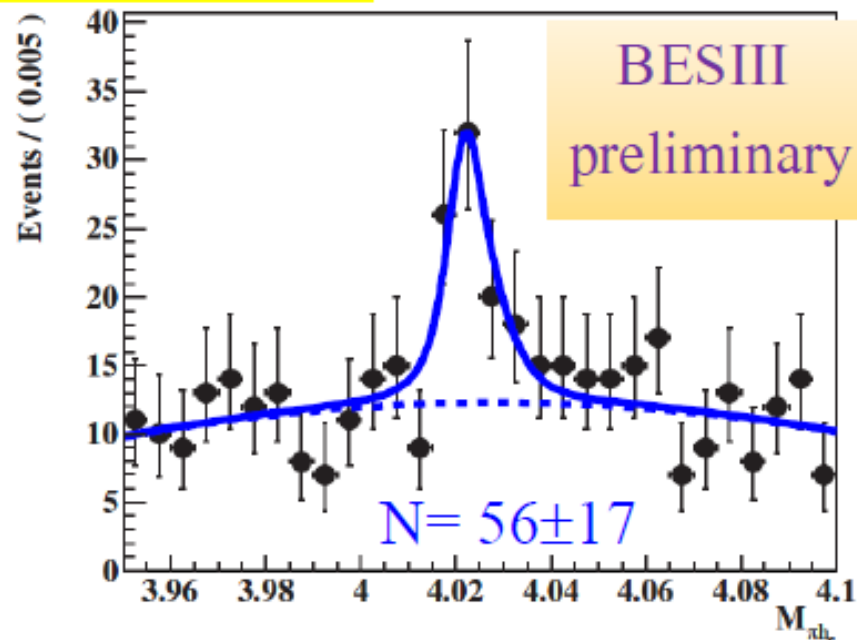

Simultaneous fit to 4.26/4.36 GeV data and 16 η_c decay modes. 6.4σ

$M(Z_c(4020)) = 4021.8 \pm 1.0 \pm 2.5$ MeV; $\Gamma(Z_c(4020)) = 5.7 \pm 3.4 \pm 1.1$ MeV

$$R = \frac{\sigma(e^+e^- \rightarrow \pi^+ Z_c^-(4020) \rightarrow \pi^+ \pi^- h_c(1P))}{\sigma(e^+e^- \rightarrow \pi^+ \pi^- h_c(1P))} = (16.2 \pm 4.1 \pm 0.7)\% \quad (16.6 \pm 5.2 \pm 0.8)\%$$

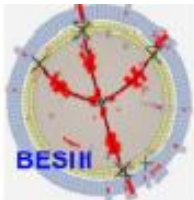

$$e^+e^- \rightarrow \pi Z_c(3885) \rightarrow \pi D \bar{D}^* + \text{c.c.}$$

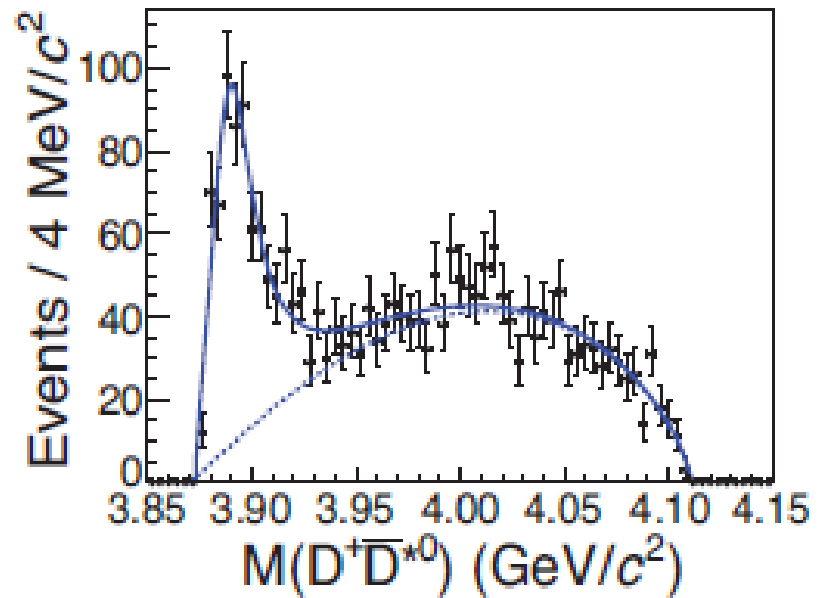
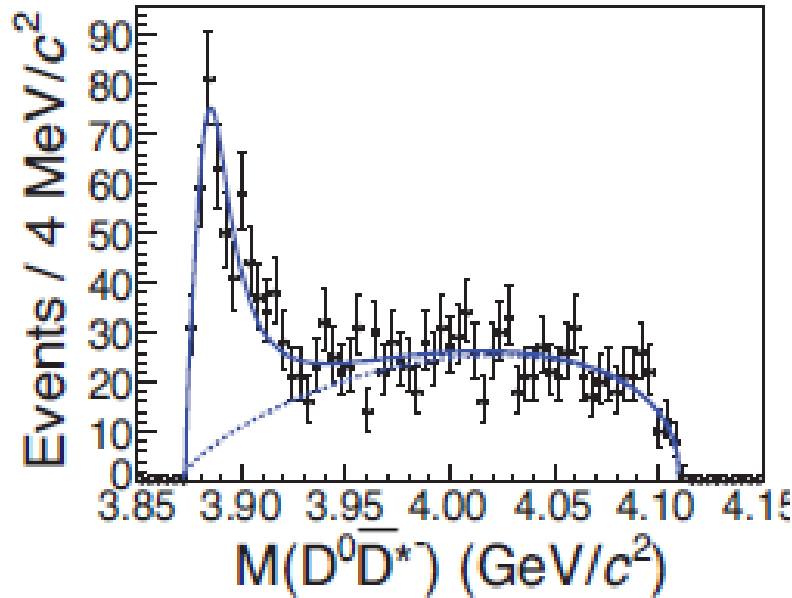

The $M(D^0 \bar{D}^{*0})$ (left) and $M(D^+ \bar{D}^{*0})$ (right) distributions for selected events. The curves are described in the text.

$$M_{\text{pole}} = (3883.9 \pm 1.5 \pm 4.2) \text{ MeV}/c^2$$

$$\Gamma_{\text{pole}} = (24.8 \pm 3.3 \pm 11.0) \text{ MeV}$$

$$\frac{\Gamma(Z_c(3885) \rightarrow D \bar{D}^*)}{\Gamma(Z_c(3900) \rightarrow \pi J/\psi)} = 6.2 \pm 1.1 \pm 2.7$$

BES III arXiv: 1310.1163v2

$Z_c(3885) = Z_c(3900) \Rightarrow$ the same question?

$Z_c(4020) = Z_c(4025)?$

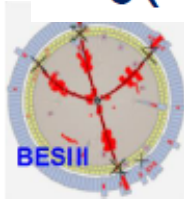

Y(4260)

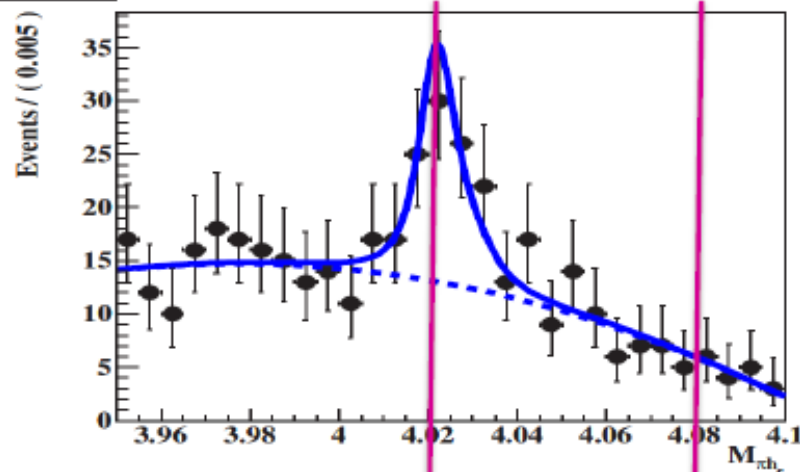

- $M(4020) = 4021.8 \pm 1.0 \pm 2.5$ MeV
- $M(4025) = 4026.3 \pm 2.6 \pm 3.7$ MeV
- $\Gamma(4020) = 5.7 \pm 3.4 \pm 1.1$ MeV
- $\Gamma(4025) = 24.8 \pm 5.6 \pm 7.7$ MeV

Close to $\bar{D}^* D^*$ threshold = 4017 MeV

Mass consistent with each other but width $\sim 2\sigma$ difference

Interference with other amplitudes may change the results

Coupling to $\bar{D}^* D^*$ is much larger than to πh_c if they are the same state

Will fit with Flatte formula

BESIII preliminary
The Z_c ' is found!

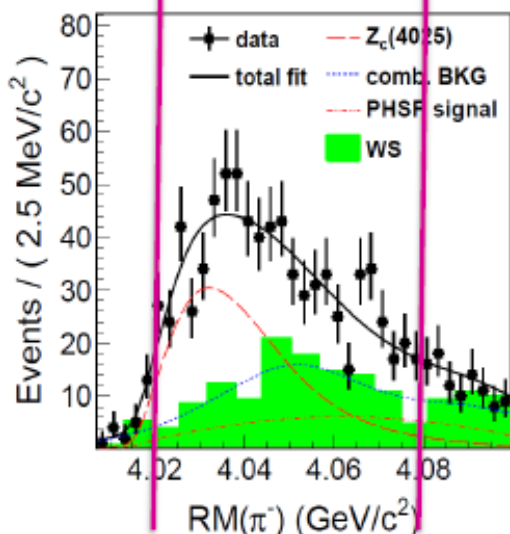

THE SPECTRUM OF SINGLET (1S_0) AND TRIPLET (3S_1) STATES OF CHARMONIUM

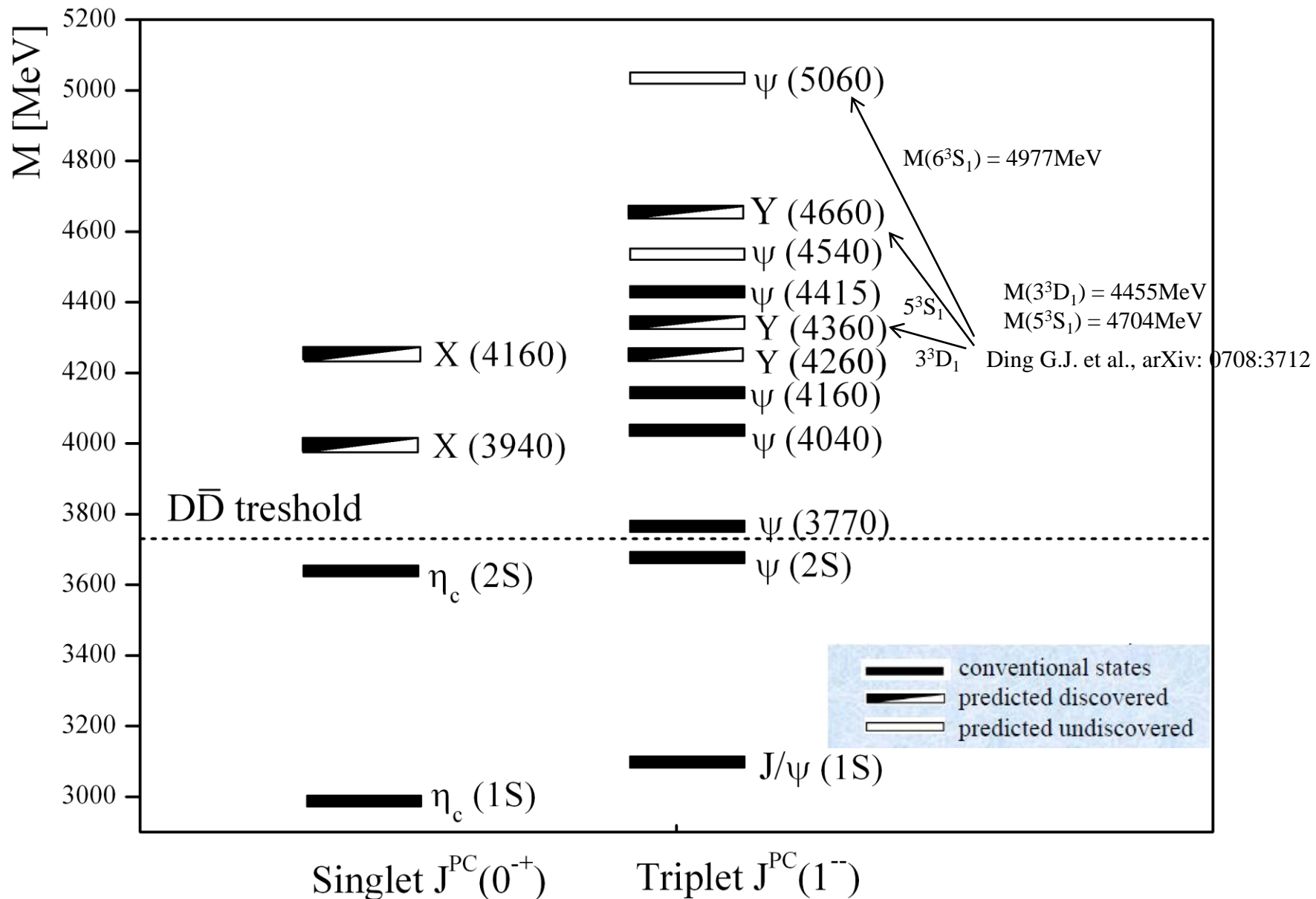

THE SPECTRUM OF SINGLET (1P_J) AND TRIPLET (3P_J) STATES OF CHARMONIUM

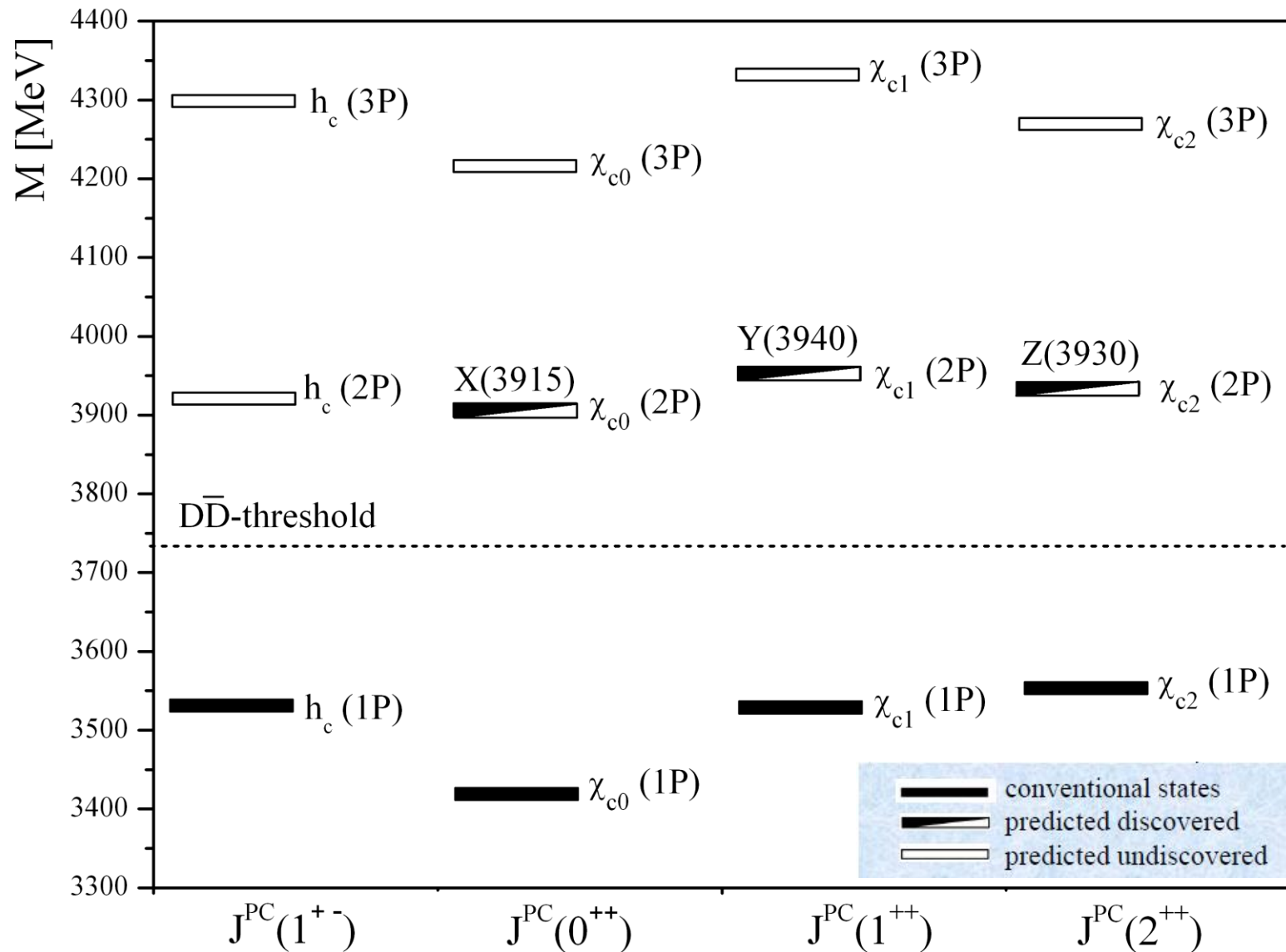

THE SPECTRUM OF SINGLET 1D_2 AND TRIPLET 3D_J STATES OF CHARMONIUM

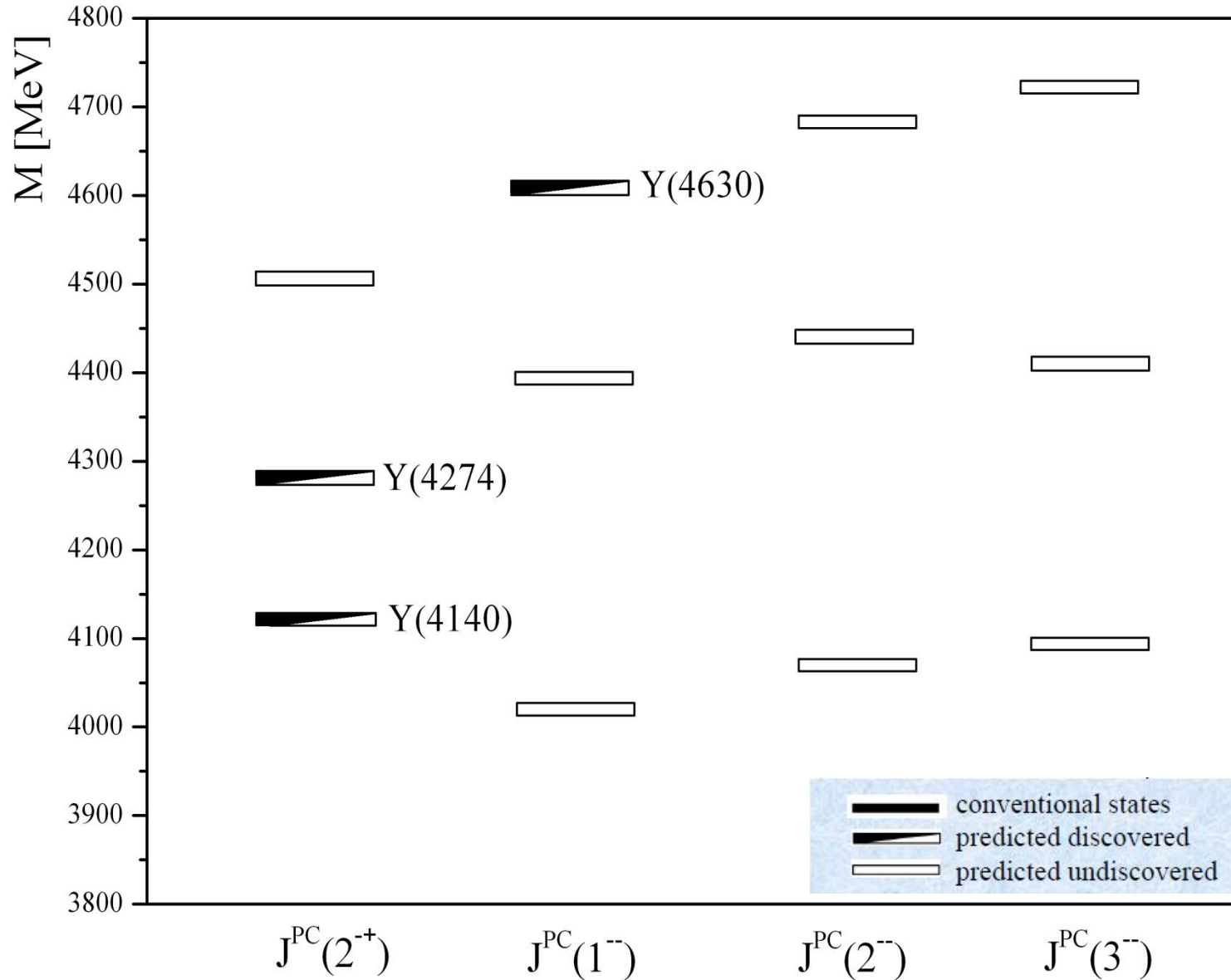

SPECTRUM OF CHARMED HYBRIDS WITH QUANTUM NUMBERS

$$J^{PC} = 3^{+-}, 2^{++}, 2^{-+}, 1^{+-}, 1^{-+}, 0^{+-}, 0^{++}.$$

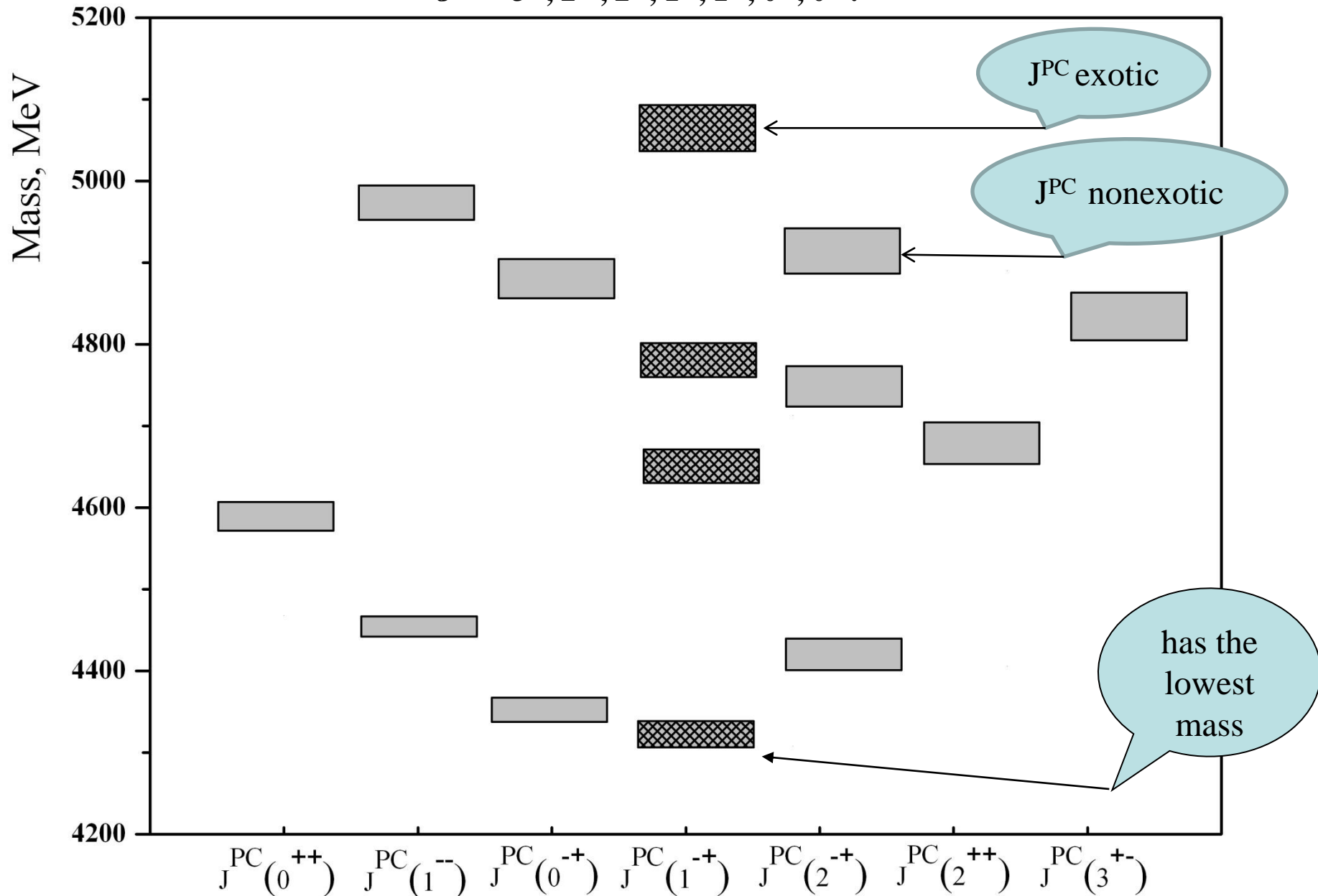

SPECTRUM OF CHARMED HYBRIDS WITH QUANTUM NUMBERS

$$J^{PC} = 3^{-+}, 2^{-}, 2^{+-}, 1^{+-}, 1^{++}, 0^{+-}, 0^{-}$$

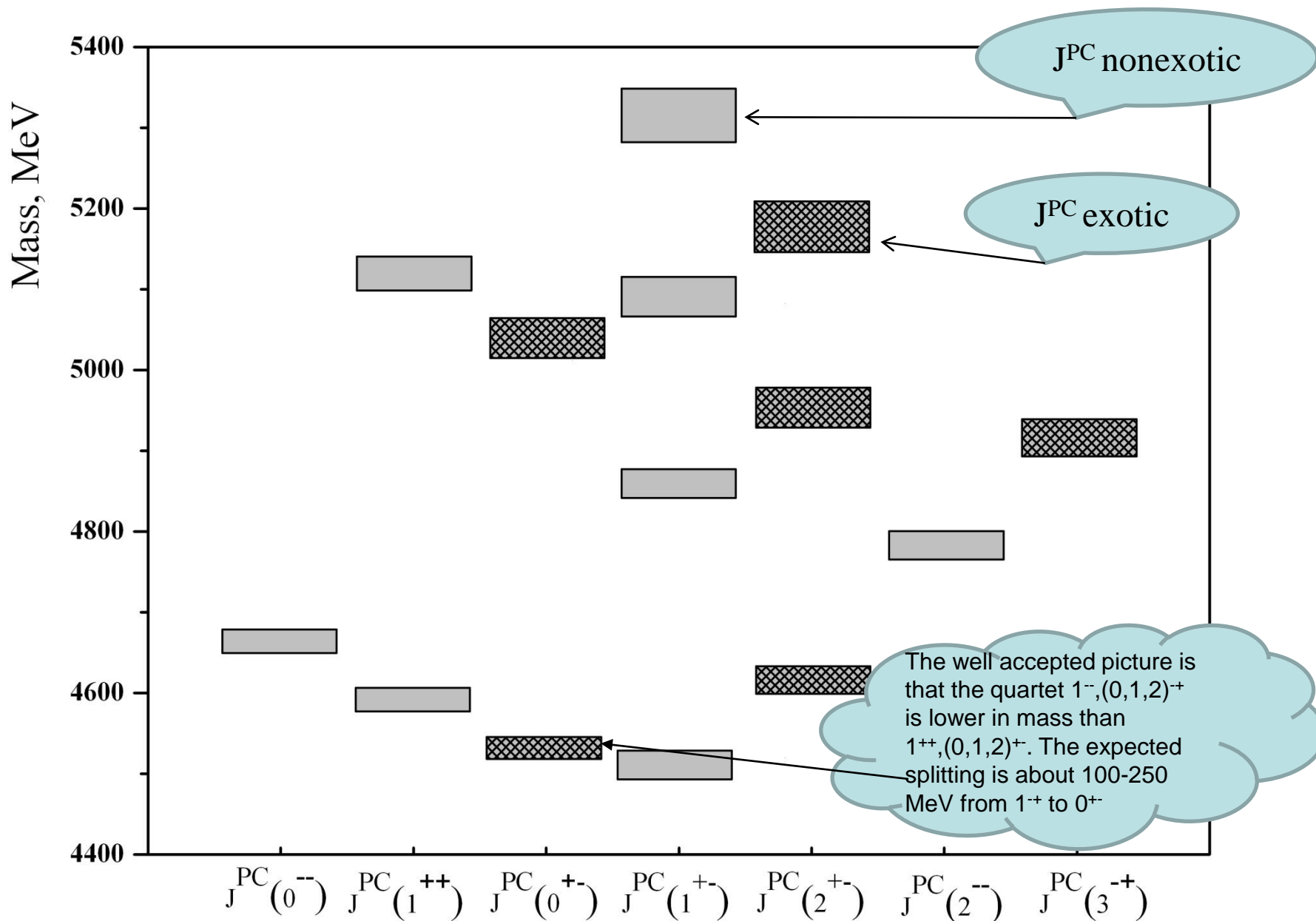

THE SPECTRUM OF TETRAQUARKS WITH THE HIDDEN CHARM

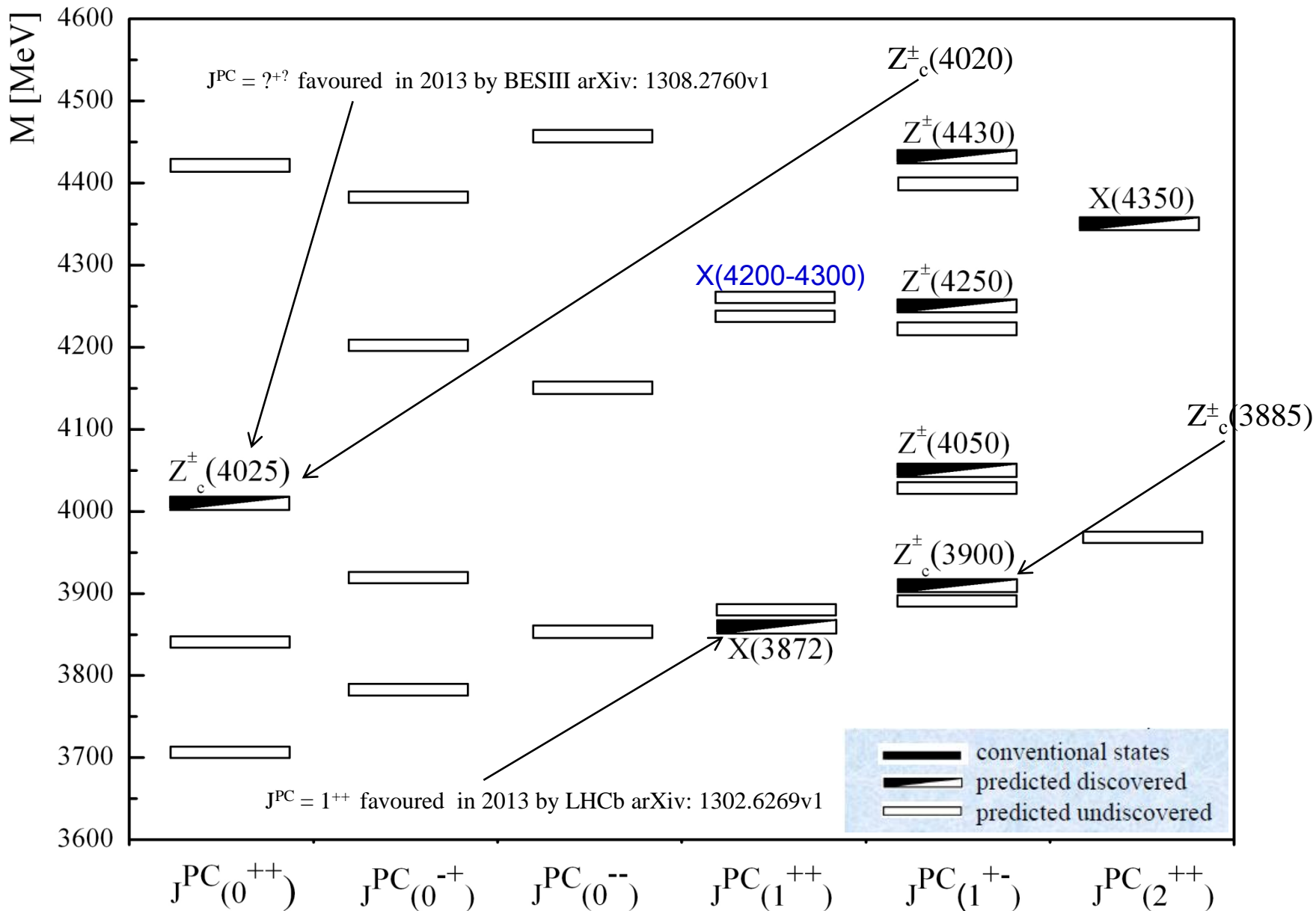

What to look for

- Does the $Z(4433)$ exist??
- Better to find charged X !
- Neutral partners of $Z(4433) \sim X(1^{+-}, 2S)$ should be close by few MeV and decaying to $\psi(2S) \pi/\eta$ or $\eta_c(2S) \rho/\omega$
- What about $X(1^{+-}, 1S)$? Look for any charged state at ≈ 3880 MeV (decaying to $\psi\pi$ or $\eta_c\rho$)
- Similarly one expects $X(1^{++}, 2S)$ states. Look at $M \sim 4200-4300$: $X(1^{++}, 2S) \rightarrow D^{(*)} D^{(*)}$
- Baryon-anti-baryon thresholds at hand (4572 MeV for $2M_{\Lambda_c}$ and 4379 MeV for $M_{\Lambda_c} + M_{\Sigma_c}$). $X(2^{++}, 2S)$ might be over bb -threshold.

CALCULATION OF WIDTHS

The integral formalism (or in other words integral approach) is based on the possibility of appearance of the discrete quasi stationary states with finite width and positive values of energy in the barrier-type potential. This barrier is formed by the superposition of two type of potentials: short-range attractive potential $V_1(r)$ and long-distance repulsive potential $V_2(r)$.

Thus, the width of a quasi stationary state in the integral approach is defined by the following expression (integral formula):

$$\Gamma = 2\pi \left| \int_0^{\infty} \phi_L(r) V(r) F_L(r) r^2 dr \right|^2$$

$$(r < R): \int_0^R |\phi_L(r)|^2 dr = 1$$

where

where $F_L(r)$ – is the regular decision in the $V_2(r)$ potential, normalized on the energy delta-function; $\phi_L(r)$ – normalized wave function of the resonance state. This wave function transforms into irregular decision in the $V_2(r)$ potential far away from the internal turning point.

The integral can be estimated with the well known approximately methods: for example, the saddle-point technique or the other numerical method.

THE WIDTHS OF TRIPLET 3S_1 CHARMONIUM STATES

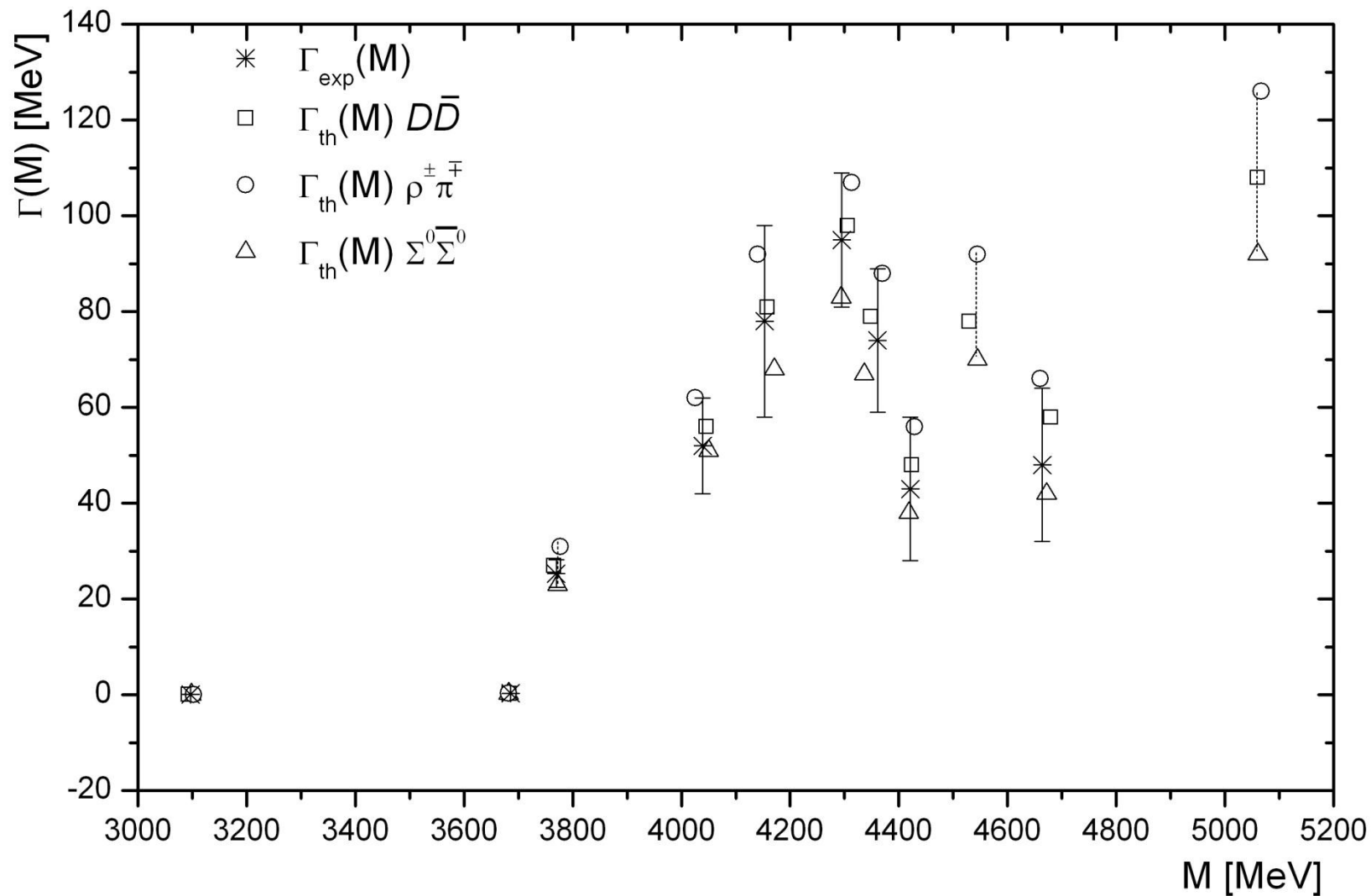

THE WIDTHS OF SINGLET 1P_1 AND TRIPLET 3P_J CHARMONIUM STATES

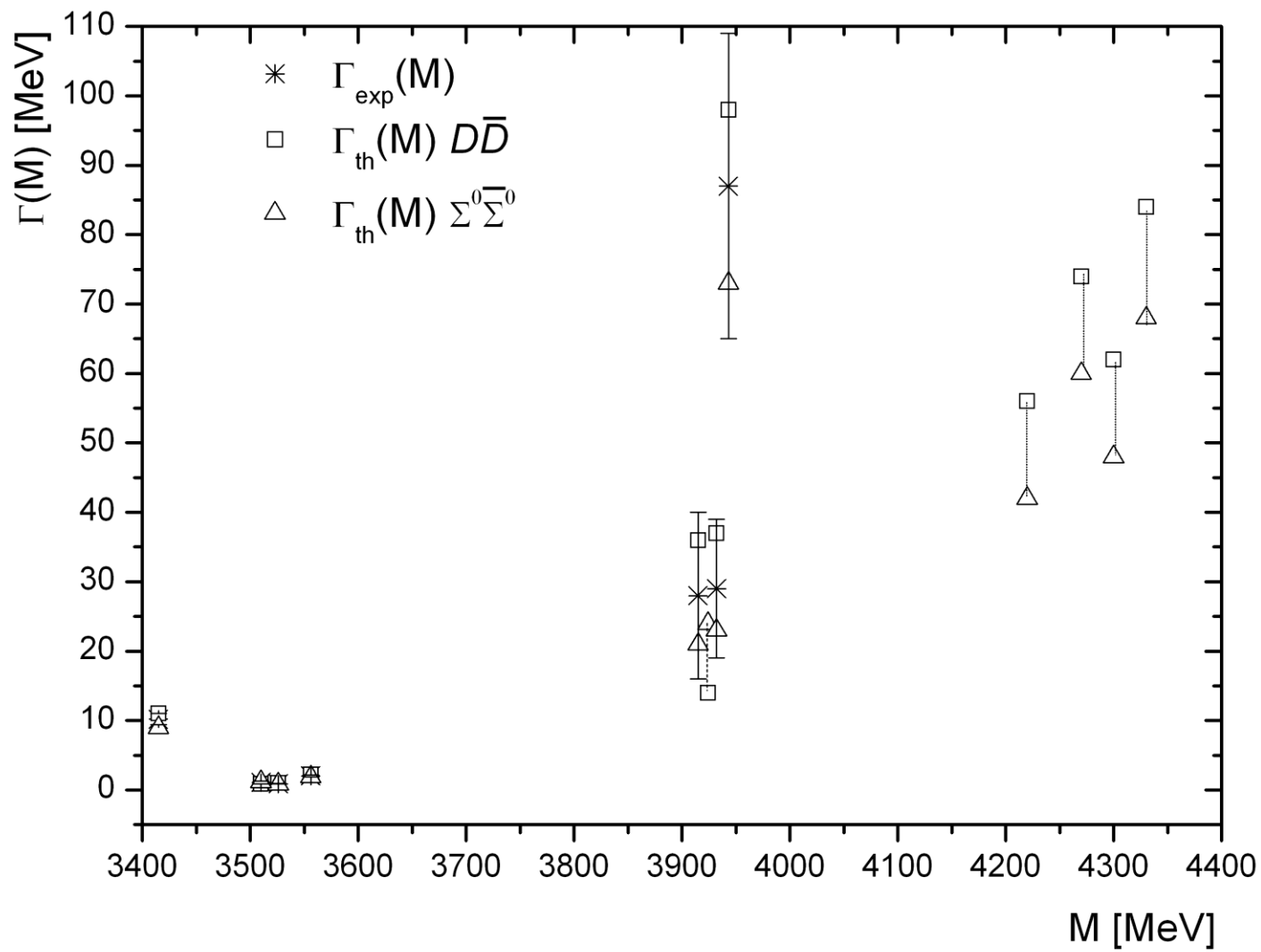

THE WIDTHS OF TETRAQUARKS WITH THE HIDDEN CHARM

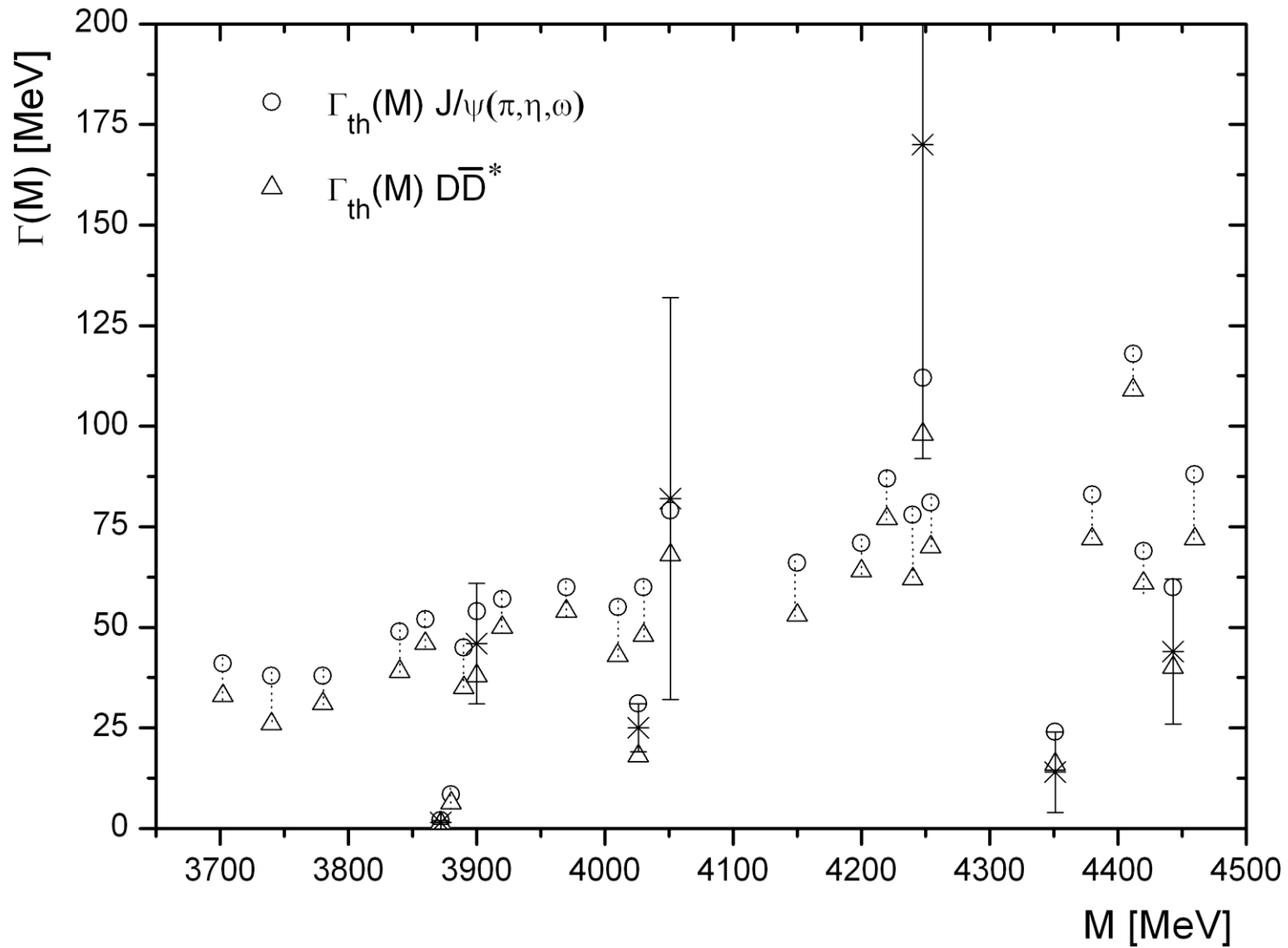

Summary

- A combined approach has been proposed to study charmonium & exotics.
- The most promising decay channels of charmonium (decays into light hadrons, particle-antiparticle, decays with J/Ψ , Ψ' and h_c in the final state), charmed hybrids (decays into charmonium & light mesons, decays into DD_J^* pair) & tetraquarks (decays into charmonium & light mesons, decays into DD^* pair) have been analyzed.
- Many different charmonium & exotic states are expected to exist in the framework of the combined approach.
- The recently discovered XYZ-particles have been analyzed. Eleven of these states can be interpreted as charmonium (two singlet 1S_0 , two singlet 1D_2 , three triplet 3S_1 , three triplet 3P_J and one triplet 3D_J) and seven as tetraquarks (two neutral and five charged). **IMPORTANT!!!** It has been shown that charge/neutral tetraquarks must have neutral/charge partners with mass values which differ by few MeV.
- Using the integral approach for the hadron resonance decay, the widths of the expected states of charmonium & exotics were calculated; they turn out to be relatively narrow; most of them are of order of several tens of MeV.
- The branching ratios of charmonium & exotics were calculated. Their values are of the order of $\beta \approx 10^{-1} - 10^{-2}$ dependent of their decay channel.
- The need for further research charmonium & exotics and their main characteristics in PANDA experiment with its high quality antiproton beam has been demonstrated.

PERSECTIVES AND FUTURE PLANS

- *D*-meson spectroscopy:

- CP*-violation
- Flavour mixing
- Rare decays

- Baryon spectroscopy:

- Strange baryons
- Charmed baryons

ACKNOWLEDGEMENT

PROF. DR. STEPHEN OLSEN

PROF. DR. VLADIMIR NIKITIN

THANK YOU!